

# SHARP®

## MODEL ***UX-CL220***

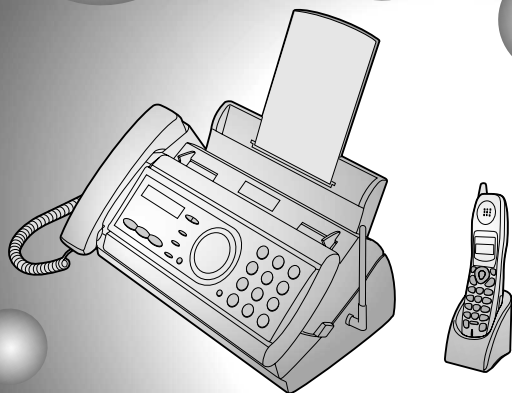

# ***FACSIMILE*** OPERATION MANUAL



[www.OpenLCR.com](http://www.OpenLCR.com)

1. **Installation**
2. **Setting Up and Using OpenLCR**
3. **Using the Answering System**
4. **Using the Cordless Handset**
5. **Sending Faxes**
6. **Receiving Faxes**
7. **Making Copies**
8. **Special Functions**
9. **Printing Lists**
10. **Maintenance**
11. **Troubleshooting**

**SHARP**

FROM SHARP MINDS  
COME SHARP PRODUCTS™



**GENUINE SUPPLIES**

To ensure Sharp quality, look for the Sharp Genuine Supplies Loop on your business products. We provide a full line of supplies that are designed and tested to maximize the life and performance of all Sharp products.

## SharpPlace

**congratulations** on the purchase of your new Sharp Product!

For your convenience, Genuine Sharp Supplies, Accessories, and additional Sharp Products can be purchased from the Authorized Sharp Reseller where you purchased your product or on-line at:

[www.SharpPlace.com](http://www.SharpPlace.com)

visit **SharpPlace** to enter periodic contests and drawings!

© 2002 Sharp Electronics Corporation  
Design and specifications are subject to change without notice.

**WARNING** - FCC Regulations state that any unauthorized changes or modifications to this equipment not expressly approved by the manufacturer could void the user's authority to operate this equipment.

**Note:** This equipment has been tested and found to comply with the limits for a Class B digital device, pursuant to Part 15 of the FCC Rules.

These limits are designed to provide reasonable protection against harmful interference in a residential installation.

This equipment generates, uses and can radiate radio frequency energy and, if not installed and used in accordance with the instructions, may cause harmful interference to radio communications. However, there is no guarantee that interference will not occur in a particular installation. If this equipment does cause harmful interference to radio or television reception, which can be determined by turning the equipment off and on, the user is encouraged to try to correct the interference by one or more of the following measures:

- Reorient or relocate the receiving antenna.
- Increase the separation between the equipment and the receiver.
- Connect the equipment into an outlet on a circuit different from that to which the receiver is connected.
- Consult the dealer or an experienced radio/TV technician for help.

## **IMPORTANT NOTICE**

### **Fax machine**

FCC Radiation Exposure Statement:

This equipment complies with FCC radiation exposure limits set forth for uncontrolled equipment.

This equipment should be installed and operated with minimum distance at least 20cm between the radiator and persons body (excluding extremities: hands, wrists, feet and legs) and must not be co-located or operated with any other antenna or transmitter.

### **Cordless handset**

For body worn operation, this phone has been tested and meets FCC RF exposure guidelines when used with an accessory that no metal and that positions the handset a minimum of 1.5cm from the body.

Use of other accessories may not ensure compliance with FCC RF exposure guidelines.

## **ABOUT THE TELEPHONE CONSUMER PROTECTION ACT OF 1991**

"The Telephone Consumer Protection Act of 1991 makes it unlawful for any person to use a computer or other electronic device to send any message via a telephone facsimile machine unless such message clearly contains in a margin at the top or bottom of each transmitted page or on the first page of the transmission the following information:

- (1) The date and time of transmission.
- (2) Identification of either the business, business entity or individual sending the message.
- (3) Telephone number of either the sending machine, business, business entity or individual.

In order to program this information into your facsimile machine, please refer to the appropriate instructions in the operation manual."



As an ENERGY STAR® partner, SHARP has determined that this product meets the ENERGY STAR® guidelines for energy efficiency.

# Introduction

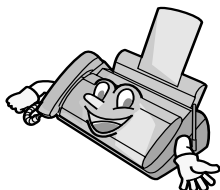

Welcome, and thank you for choosing a Sharp fax machine! The features and specifications of your new Sharp fax are shown below.

## Fax machine and general specifications.

<b>Automatic dialing</b>	30 numbers
<b>Imaging film</b>	<b>Initial starter roll</b> (included with machine): 32 ft. (10 m) (approx. 30 letter-size pages) <b>Replacement roll</b> (not included): <b>UX-5CR</b> 164 ft. (50 m) (one roll yields approx. 150 letter-size pages)
<b>Memory size*</b>	504 KB (approx. 30 average pages with no voice messages recorded and ECM turned off, or 20 minutes of voice messages (including OGMs) with no faxes in memory)
<b>Modem speed</b>	14,400 bps with automatic fallback to lower speeds.
<b>Transmission time*</b>	Approx. 6 seconds (only when ECM is on)
<b>Resolution</b>	<b>Horizontal:</b> 203 pels/inch (8 pels/mm) <b>Vertical:</b> Standard: 98 lines/inch (3.85 lines/mm) Fine /Halftone: 196 lines/inch (7.7 lines/mm) Super fine: 391 lines/inch (15.4 lines/mm)
<b>Automatic document feeder</b>	10 pages max. (letter/A4, 20 lb paper)
<b>Recording system</b>	Thermal transfer recording
<b>Display</b>	16-digit LCD display

\*Based on Sharp Standard No. 1 Chart at standard resolution in Sharp special mode, excluding time for protocol signals (i.e., ITU-T phase C time only).

<b>Halftone (grayscale)</b>	64 levels
<b>Compression scheme</b>	MR, MH, MMR
<b>Applicable telephone line</b>	Public switched telephone network
<b>Paper tray capacity</b>	Letter: Approx. 50 sheets (20-lb. copier paper at room temperature; maximum stack height should not be higher than the line on the tray) Legal: 5 sheets Recommended paper weight: 20-lb. Copy Bond
<b>Compatibility</b>	ITU-T (CCITT) G3 mode
<b>Input document size</b>	<b>Automatic feeding:</b> Width: 5.8 to 8.5" (148 to 216 mm) Length: 5.5 to 11" (140 to 279 mm) <b>Manual feeding:</b> Width: 5.8 to 8.5" (148 to 216 mm) Length: 5.5 to 23.6" (140 to 600 mm)
<b>Effective scanning width</b>	8.3" (210 mm) max.
<b>Effective printing width</b>	8.3" (210 mm) max.
<b>Contrast control</b>	Automatic/Dark selectable
<b>Reception modes</b>	TEL/FAX/TAD
<b>Copy function</b>	Single / Multi (99 copies/page)
<b>Telephone function</b>	Yes (cannot be used if power fails)
<b>Power requirements</b>	120 V AC, 60 Hz
<b>Operating temperature</b>	41 - 95°F (5 - 35°C)
<b>Humidity</b>	25 - 85% RH
<b>Power consumption</b>	Standby: 4.3 W Maximum: 100 W
<b>Dimensions</b> (without attachments)	Width: 13.9" (353 mm) Depth: 7.6" (193 mm) Height: 6.9" (174 mm)
<b>Weight</b> (without attachments)	Approx. 6.2 lbs. (2.8 kg)

## ***Cordless handset specifications.***

<b>Frequency</b>	2.4 GHz (2.405 to 2.475 GHz)
<b>Dimensions</b>	Width: 1.8" (46 mm) Depth: 1.7" (42 mm) Height: 7.1" (180 mm) (not including antenna)
<b>Weight</b>	Approx. 0.3 lbs. (115 g) (without battery)
<b>Battery</b>	3.6 V Ni-MH battery; capacity: 850 mAh
<b>Power consumption</b>	Approx. 1.0 W (in standby mode)
<b>Initial charging</b>	Approx. 10 hours for initial charge
<b>Battery life</b>	Approx. 4 hours (240 minutes) (at room temperature)
<b>Battery life in standby mode</b>	Approx. 3 days with one full charge (at room temperature) <i>Battery life (both normal and in standby mode) may vary depending on usage, range from base machine, and environmental conditions such as temperature.</i>

As a part of our policy of continuous improvement, SHARP reserves the right to make design and specification changes for product improvement without prior notice. The performance specification figures indicated are nominal values of production units. There may be some deviations from these values in individual units.

### **Important:**

This fax machine is not designed for use on a line which has call waiting, call forwarding, or certain other special services offered by your telephone company. If you attempt to use the fax machine in conjunction with any of these services, you may experience errors during transmission and reception of facsimile messages. The fax machine is not compatible with digital telephone systems.

## ***Important safety information***

Do not disassemble this machine or attempt any procedures not described in this manual. Refer all servicing to qualified service personnel.

Do not install or use the machine near water, or when you are wet. For example, do not use the machine near a bath tub, wash bowl, kitchen sink or laundry tub, in a wet basement, or near a swimming pool. Take care not to spill any liquids on the machine.

Unplug the machine from the power outlet and telephone jack and consult a qualified service representative if any of the following situations occur:

- Liquid has been spilled into the machine or the machine has been exposed to rain or water.
- The machine produces odors, smoke, or unusual noises.

- The power cord is frayed or damaged.
- The machine has been dropped or the housing damaged.

Do not allow anything to rest on the power cord, and do not install the machine where people may walk on the power cord.

This machine must only be connected to a 120 V, 60 Hz, grounded (3-prong) outlet. Connecting it to any other kind of outlet will damage the machine and invalidate the warranty.

Never insert objects of any kind into slots or openings on the machine. This could create a risk of fire or electric shock. If an object falls into the machine that you cannot remove, unplug the machine and consult a qualified service representative.

Do not place this machine on an unstable cart, stand or table. The machine could be seriously damaged if it falls.

Never install telephone wiring during a lightning storm.

Never install telephone jacks in wet locations unless the jack is specifically designed for wet locations.

Never touch bare telephone wires or terminals unless the telephone line has been disconnected at the network interface.

Use caution when installing or modifying telephone lines.

Avoid using a telephone (other than a cordless type) during an electrical storm. There may be a remote risk of electric shock from lightning.

Do not use a telephone to report a gas leak in the vicinity of the leak.

The power outlet must be installed near the equipment and must be easily accessible.

## **Battery**

Use only the battery specified in this manual. Use only the provided charger to charge the battery.

Do not open or mutilate the battery pack. Corrosive fluid may leak out and cause injury or burns to the eyes and skin. The fluid may be toxic if swallowed. In case of contact with eyes, flush with clean water (do not rub), and seek medical attention immediately.

Do not store or carry the battery with other metal objects such as keys or pins. These may short the battery and cause it to overheat.

Do not allow the battery to become wet.

Do not dispose of the battery in a fire or heat the battery. The battery may explode.

## **Health care facilities and equipment**

Radio frequency energy emitted from the cordless handset equipment may cause medical equipment to malfunction. Verify that any personal medical equipment you are using is adequately shielded from external radio frequency energy before using the cordless handset equipment. Do not use the cordless handset equipment in health care facilities where such use is prohibited.

---

# ***Table of Contents***

<b>A Look at the Operation Panel</b>	<b>7</b>
<hr/>	
<b>1. Installation</b>	<b>12</b>
<hr/>	
Unpacking Checklist . . . . .	12
Setting Up . . . . .	13
Loading the Imaging Film . . . . .	21
Loading Printing Paper . . . . .	23
Entering Your Name and Fax Number . . . . .	25
Setting the Date and Time . . . . .	27
Setting the Reception Mode . . . . .	29
Volume Adjustment - Fax Machine . . . . .	30
Volume Adjustment - Cordless Handset . . . . .	31
<b>2. Setting Up and Using OpenLCR</b>	<b>33</b>
<hr/>	
<b>3. Using the Answering System</b>	<b>43</b>
<hr/>	
Recording an Outgoing Message . . . . .	43
Operating the Answering System . . . . .	44
Optional Answering System Settings . . . . .	48
Transfer Function . . . . .	50
Override Ringing . . . . .	53
Remote Operations . . . . .	55
<b>4. Using the Cordless Handset</b>	<b>61</b>
<hr/>	
Making a Phone Call . . . . .	61
Receiving a Phone Call . . . . .	62
Receiving a Fax Using the Cordless Handset . . . . .	63
Storing and Using Auto-Dial Numbers . . . . .	63
Redial . . . . .	67
Using the Intercom Feature . . . . .	68
Transferring Calls . . . . .	69
Using REMOTE MODE . . . . .	71
<b>5. Sending Faxes</b>	<b>73</b>
<hr/>	
Transmittable Documents . . . . .	73

## Table of Contents

Loading the Document . . . . .	74
Adjusting the Resolution and Contrast . . . . .	75
Sending a Fax by Normal Dialing . . . . .	77
Sending a Fax by Automatic Dialing . . . . .	78
Sending a Fax From Memory . . . . .	85
<b>6. Receiving Faxes</b>	<b>87</b>
<hr/>	
Using FAX Mode . . . . .	87
Using TEL Mode . . . . .	88
Optional Reception Settings . . . . .	90
Substitute Reception to Memory . . . . .	92
<b>7. Making Copies</b>	<b>93</b>
<hr/>	
<b>8. Special Functions</b>	<b>95</b>
<hr/>	
Caller ID (Requires Subscription to Service) . . . . .	95
Distinctive Ring (Requires Subscription to Service) . . . . .	101
Blocking Reception of Unwanted Faxes . . . . .	102
<b>9. Printing Lists</b>	<b>103</b>
<hr/>	
<b>10. Maintenance</b>	<b>107</b>
<hr/>	
Replacing the Cordless Handset Battery . . . . .	110
<b>11. Troubleshooting</b>	<b>112</b>
<hr/>	
Problems and Solutions . . . . .	112
Messages and Signals . . . . .	118
Clearing Paper Jams . . . . .	123
Ordering Parts . . . . .	125
FCC Regulatory Information . . . . .	126
<b>Quick Reference Guide</b>	<b>129</b>
<hr/>	
<b>Guía de referencia rápida</b>	<b>131</b>
<hr/>	
<b>Index</b>	<b>133</b>
<hr/>	



# A Look at the Operation Panel

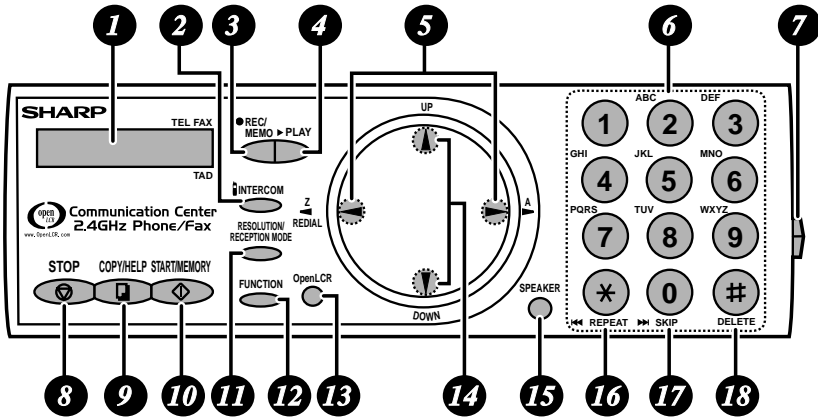

- 1 Display**  
This displays messages and prompts to help you operate the machine.
- 2 INTERCOM key**  
Press this key to page or locate the cordless handset.
- 3 REC/MEMO key**  
Press this key to record an outgoing message, phone conversation, or memo.
- 4 PLAY key**  
Press this key to play recorded messages.
- 5 Left and right arrow keys**  
**Auto-dial numbers:** When sending a fax or making a phone call, press these keys to scroll through your auto-dial numbers, the "REVIEW CALLS" list (only available if you have Caller ID), and the last number dialed (redial).  
**FUNCTION key settings:** Press the right arrow key after scrolling with the up and down arrow keys to select a **FUNCTION** key setting.
- 6 Number keys**  
Use these keys to dial numbers, and enter numbers and letters when storing auto-dial numbers.
- 7 Panel release**  
Press this release to open the operation panel.
- 8 STOP key**  
Press this key to cancel an operation before it is completed.

- 9 COPY/HELP key**  
When a document is in the feeder, press this key to make a copy of a document. At any other time, press this key to print out the Help List, a quick reference guide to the operation of your fax machine.
- 10 START/MEMORY key**  
Press this key after dialing to begin fax transmission. Press this key before dialing to send a fax through memory. The key can also be pressed in the date and time display to show the percentage of memory currently used.
- 11 RESOLUTION / RECEPTION MODE key**  
When a document is in the feeder, press this key to adjust the resolution for faxing or copying. At any other time, press this key to select the reception mode (an arrow in the display will point to the currently selected reception mode).
- 12 FUNCTION key**  
Press this key followed by the arrow keys to select special functions and settings.
- 13 OpenLCR key**  
Press this key to register for OpenLCR service and receive rate information to your fax.
- 14 UP and DOWN arrow keys**  
**Enlarge/reduce setting:** When making a copy of a document, press these keys to select an enlarge/reduce setting.  
**Volume setting:** When a document is not in the feeder, press these keys to change the handset volume when the handset is lifted, the speaker volume when the **SPEAKER** key has been pressed, or the ringer volume at any other time.  
**FUNCTION key settings:** Press these keys after pressing the **FUNCTION** key to scroll through the FUNCTION MODE settings.
- 15 SPEAKER key**  
Press this key to listen to the line and fax tones through the speaker when faxing a document.  
Note: **This is not a speakerphone.** You must pick up the handset to talk with the other party.
- 16 REPEAT key**  
Press this key while listening to a message to play it again.
- 17 SKIP key**  
Press this key while listening to a message to skip to the next message.
- 18 DELETE key**  
Press this key to erase recorded messages.

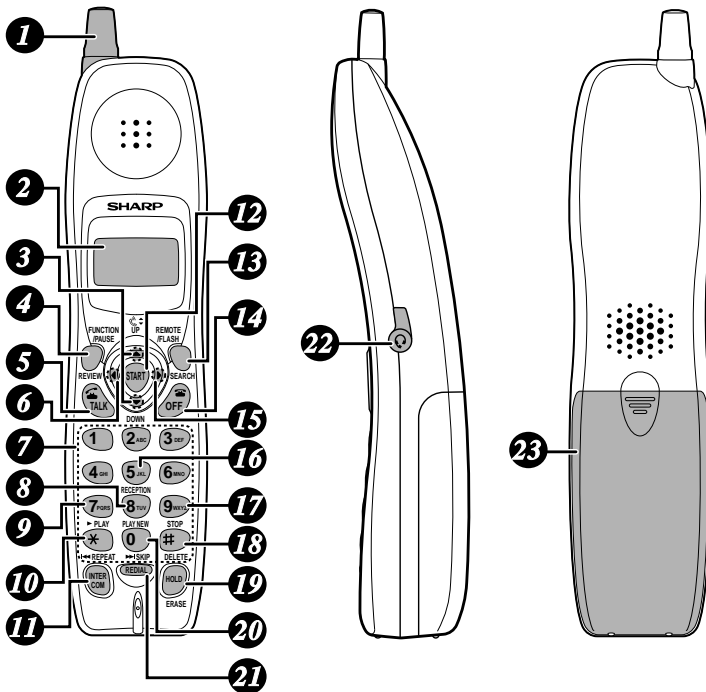

**1** Antenna

**2** Display

This displays messages and prompts to help you use the cordless handset.

**3** UP and DOWN arrow keys

**Receiver volume:** When talking on the cordless handset, press these keys to adjust the receiver volume. This also adjusts the volume when using a headset (purchased separately) connected to the cordless handset.

**Ringer volume:** When not talking on the cordless handset, press these keys to adjust the cordless handset ringer volume.

**Scroll through numbers:** Press these keys to scroll when searching for an auto-dial number or reviewing received calls (only available when you have Caller ID).

**4** FUNCTION/PAUSE key

Press this key to after pressing  SEARCH to store a new auto dial number.

When entering an auto-dial number, press this key to insert a pause between digits.

**5**

**TALK key**

Press this key to make or answer a call.

**6**

**REVIEW (left) arrow key**

Press the **REVIEW** arrow key and then the **UP** or **DOWN** arrow key to scroll through your 30 most recent calls (only available if you have Caller ID). This key can also be used to move the cursor left when entering or editing an auto-dial number or name.

**7**

**Number keys**

Use these keys to dial numbers, and enter numbers and letters when storing auto-dial numbers.

**8**

**PLAY NEW key**

Press this key after pressing  to listen to new messages recorded in the answering system.

**9**

**PLAY key**

Press this key after pressing  to listen to all messages recorded in the answering system.

**10**

**REPEAT key**

Press this key while listening to a message to play it again.

**11**

**INTERCOM key**

Press this key to page the fax machine.

**12**

**START key**

Press this key to start fax reception from the cordless handset, or to complete entries when storing, editing, or deleting auto-dial numbers.

**13**

**REMOTE/FLASH key**

Press this key to perform remote operations on the fax machine. The key is also used to access special services from your phone company that require subscription (contact your phone company for details).

**14**

**OFF key**

Press this key to end a call.

**15**

**SEARCH (right) arrow key**

Press the **SEARCH** arrow key and then the **UP** or **DOWN** arrow key to scroll through your auto-dial numbers. This key can also be used to move the cursor right when entering or editing an auto-dial number or name.

**16 RECEPTION key**

Press this key after pressing  to change the reception mode on the fax machine.

**17 STOP key**

Press this key to stop playback of messages recorded in the answering system.

**18 DELETE**

Press this key while listening to a message to delete it. To delete all your messages, press this key after playback ends (while the display shows REMOTE MODE), followed by .

**19 HOLD/ERASE key**

**Hold:** Press this key during a call to put the other party on hold.

**Erase:** Press this key to delete a phone number when searching through your recently received calls (only when you have Caller ID), or when searching through your auto-dial numbers. Press the key to delete a digit or character when storing or editing an auto-dial number.

**20 SKIP key**

Press this key while listening to your messages to skip to the next message.

**21 REDIAL key**

Press this key to redial the last number dialed using the cordless handset.

**22 Headset jack**

This jack lets you connect a headset (purchased separately) to the cordless handset.

**23 Battery cover**

Remove this cover to install or replace the handset battery.

# 1. Installation

## Unpacking Checklist

Before setting up, make sure you have all of the following items.



If any are missing, contact your dealer or retailer.



Paper tray

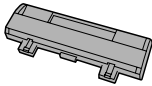

Paper tray extension



Operation manual

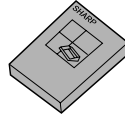

Gears (2)



Handset



Handset cord

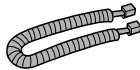

Telephone line cord



Imaging film (initial starter roll)

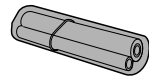

Cordless handset



Battery cover



Battery pack



AC adapter

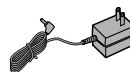

Cordless handset charger



# Setting Up

## Selecting a location for the fax machine

To maximize the talking range of the cordless handset and minimize interference, we recommend installing the fax machine in a high and central location away from obstructions such as walls.

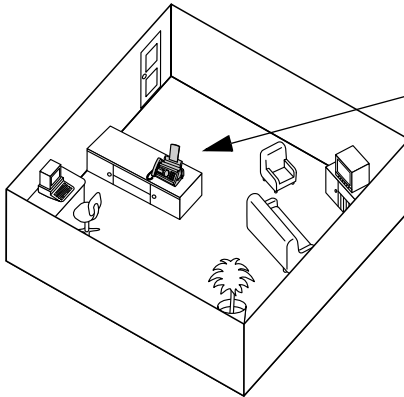

High and central location with no obstructions

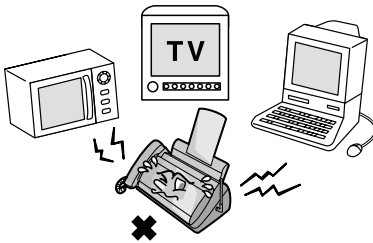

Keep the fax machine away from other electrical appliances such as TVs, microwave ovens, computers, and other cordless phones.

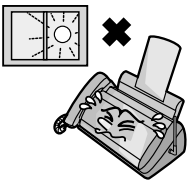

Do not place the machine in direct sunlight.

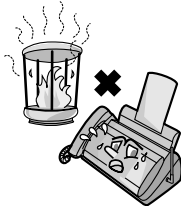

Do not place the machine near heaters or air conditioners.

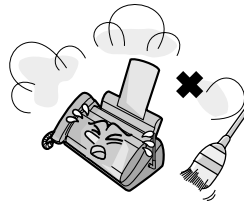

Keep dust away from the machine.

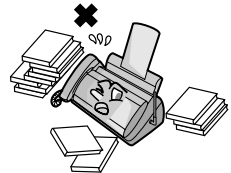

Keep the area around the machine clear.

## Connecting the handset

Connect the handset as shown and place it on the handset rest.

- ◆ The ends of the handset cord are identical, so they will go into either jack.

Make sure the handset cord goes into the jack marked with a handset symbol on the side of the machine!

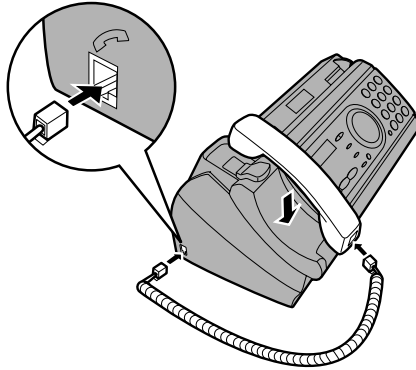
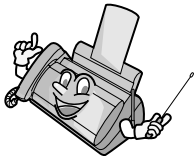

Use the handset to make ordinary phone calls, or to transmit and receive faxes manually.

## Connecting the power cord

Plug the power cord into a 120 V, 60 Hz, grounded AC (3-prong) outlet.

### Caution!

Do not plug the power cord into any other kind of outlet. This will damage the machine and is not covered under the warranty.

The machine does not have a power on/off switch, so the power is turned on and off by simply plugging in or unplugging the power cord.

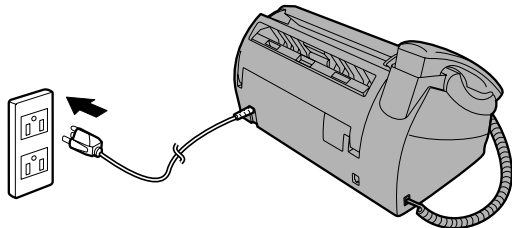



## Connecting the telephone line cord

Insert one end of the line cord into the jack on the back of the machine marked **TEL. LINE**. Insert the other end into a standard (RJ11C) single-line wall telephone jack.

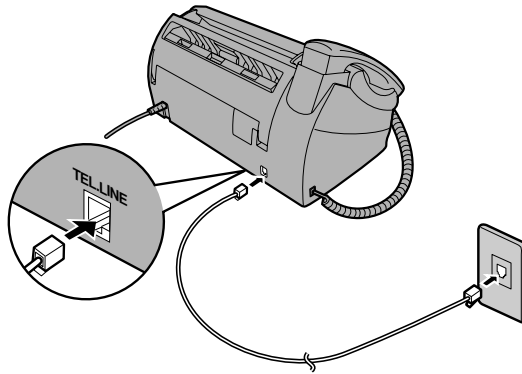

### Setting the dial mode

The fax machine is set for tone dialing. If you are on a pulse dial line, you must set the fax machine for pulse dialing. Press the panel keys as follows:

**1** Press **FUNCTION** once and **▲** twice.

Display:

OPTION SETTING

**2** Press **▶** once and **▼** twice.

DIAL MODE

**3** Press **▶** once.

1=TONE, 2=PULSE

**4** Select the dial mode:

TONE: (1) PULSE: (2)

The display briefly shows your selection, then:

DISTINCTIVE

**5** Press **STOP** to exit.

**Note:** If your area experiences a high incidence of lightning or power surges, we recommend that you install surge protectors for the power and telephone lines. Surge protectors can be purchased at most telephone specialty stores.

### **About condensation**

If the machine is moved from a cold to a warm place, it is possible that condensation may form on the scanning glass, preventing proper scanning of documents for transmission. To remove the condensation, turn on the power and wait approximately two hours before using the machine.

## ***Attach the paper tray and paper tray extension***

Attach the paper tray.

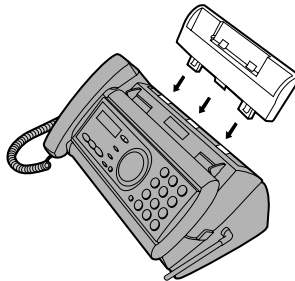

Attach the paper tray extension.

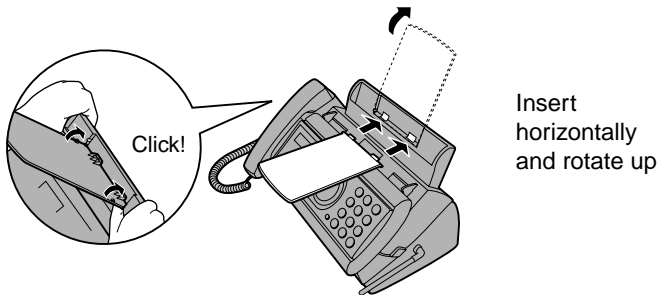

**Note:** The paper tray extension has a top side and a bottom side. If the tabs do not go into the holes, turn the support over.

## Raising the base antenna

Raise the base antenna to ensure clear communication with the cordless handset.

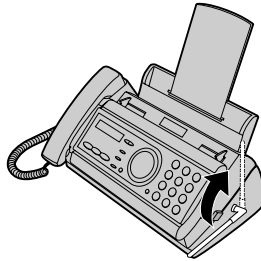

## Connecting the cordless handset charger

- 1 Connect the AC adapter to the cordless handset charger.

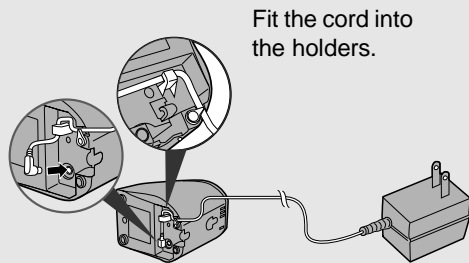

- 2 Plug the AC adapter into a standard 120 V AC outlet.

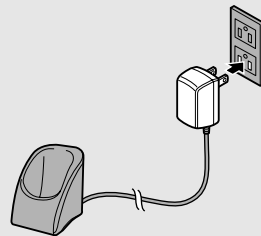

**Important:** Never cover the charger and AC adapter with a blanket, cloth, or other material. Excessive heating may result and cause fire.

## Installing the battery and charging the cordless handset

### 1 Connect the battery connector ❶, and then place the battery pack in the cordless handset.

- Place the wires as shown.

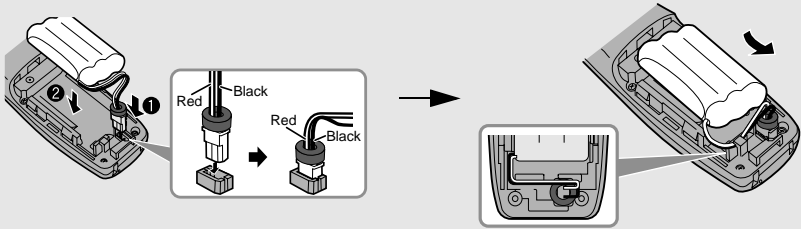

### 2 Place the battery cover on the cordless handset, making sure it snaps firmly into place.

- Make sure the wires are not caught or pinched by the cover.

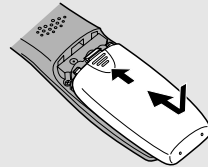

### 3 Place the cordless handset in the charger with the dial pad facing forward.

- **Important!** The dial pad must face forward, or the battery will not charge.
- The battery charges automatically while the cordless handset is in the charger. While charging, the display shows CHARGING. When charging is completed, the display shows IN CHARGER.
- The cordless handset and charger may feel warm while charging. This is normal.

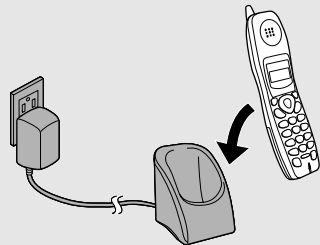

Charge the battery at least **10 hours** the first time!

The battery cannot be overcharged. When not using the cordless handset, keep it in the charger to ensure that it is always charged.

When the battery needs charging, LOW BATTERY will appear in the display and you will hear beeps during a phone conversation. If you need to continue the conversation, press  to transfer the call to the fax machine. Place the cordless handset in the charger and let it charge.

**Note:** If the battery is extremely low, nothing may appear in the display during the first several minutes that the cordless handset is in the charger. The battery will begin to charge normally after several minutes.

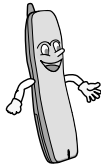

To ensure that the battery charges properly, wipe the charger contacts once a month with a cotton swab.

### Talking range

The talking range of the cordless handset is approximately 1200 ft. (400 m) (line of sight). If you hear noise or interference while talking on the cordless handset, move closer to the fax machine.

- ◆ When outside the talking range, OUT OF RANGE appears in the display. If you move out of the talking range while talking on the cordless handset, the handset will beep and you may hear interference.

Large metal objects, metal structures, and thick walls reduce the talking range.

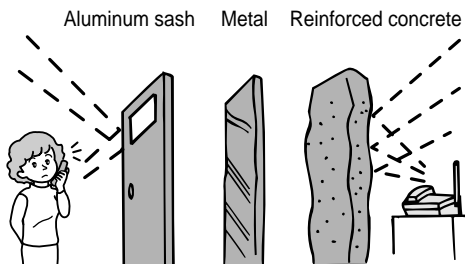

## ***Connecting a headset***

You can connect a headset (purchased separately) to the headset jack. Remove the cap and insert the connector as shown.

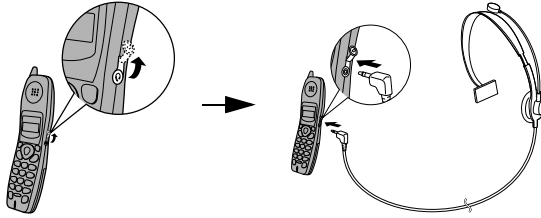

# Loading the Imaging Film

Your fax uses a roll of imaging film to create printed text and images. The print head in the fax applies heat to the imaging film to transfer ink to the paper. Follow the steps below to load or replace the film.

The initial starter roll of imaging film included with your fax can print about 30 letter-size pages.



When replacing the film, use a roll of Sharp **UX-5CR** imaging film. One roll can print about 150 letter-size pages.



Use only Sharp Genuine Supplies with this logo:

**GENUINE SUPPLIES**

**1** Remove the paper from the paper tray and open the operation panel (press **1**).

If you are loading the imaging film for the first time, go to Step 4.

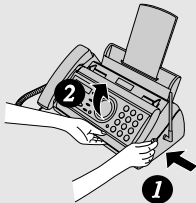

**2** Remove the used film and empty spool.

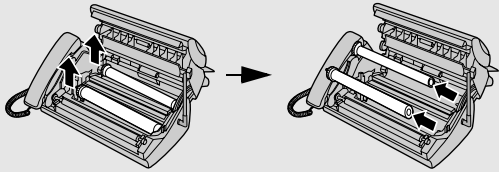

**3** Remove the two green gears from the spools. **DO NOT DISCARD THE TWO GREEN GEARS!**

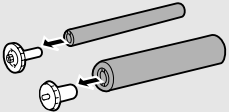

**4 Remove the new roll of imaging film from its packaging.**

- Cut the band that holds the rolls together.

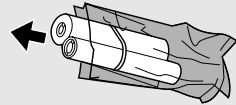

**5 Insert the green gears.**

Make sure the gears fit into the slots in the ends of the rolls.

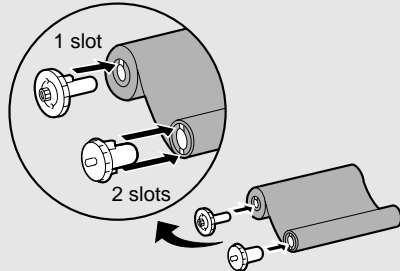

**6 Insert the film into the print compartment.**

Fit ends of rolls onto hubs

Thick roll to rear

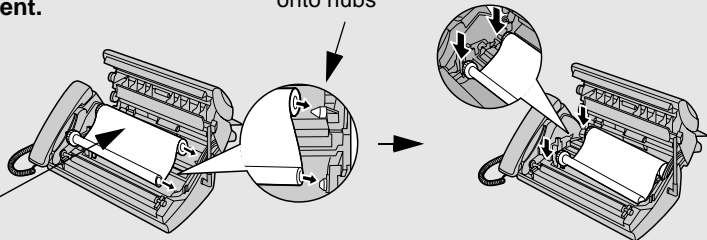

**7 Rotate the front gear as shown until the film is taut.**

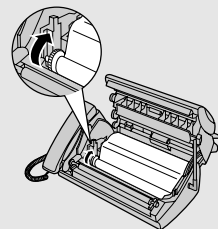

**8 Close the operation panel (press down on both sides to make sure it clicks into place).**

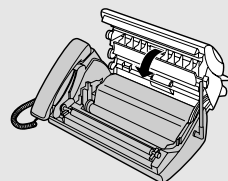



## Loading Printing Paper

You can load letter or legal size paper in the paper tray. Recommended paper weight is 20-lb. Copy Bond. The maximum number of sheets is as follows:

**Letter size:** Approx. 50 sheets (20-lb. copier paper at room temperature; maximum stack height should not be higher than the line on the tray)

**Legal size:** 5 sheets

- 1 Fan the paper, and then tap the edge against a flat surface to even the stack. Make sure the stack edges are even.**

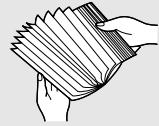

- 2 Insert the stack of paper into the tray, *PRINT SIDE DOWN*.**

- If paper remains in the tray, take it out and combine it into a single stack with the new paper.
- Be sure to load the paper so that printing takes place on the **print** side of the paper. Printing on the reverse side may result in poor print quality.
- **GENTLY LOAD PAPER INTO THE PAPER TRAY.**
- **DO NOT FORCE IT DOWN INTO THE FEED SLOT.**

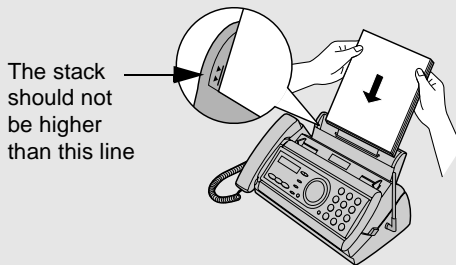

**Note:** Do not use paper that has already been printed on, or paper that is curled.

**Note:** If at any time the display shows the alternating messages at right, check the printing paper. If the tray is empty, add paper. If there is paper in the tray, take it out and then reinsert it.

When you are finished, press .











ADD PAPER &



PRESS START KEY

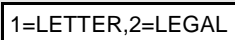











## Setting the paper size

The fax has been set at the factory to scale received faxes to letter size paper. If you loaded legal paper, you must change the paper size setting to LEGAL.

<b>1</b> Press  once and  twice.	Display: 
<b>2</b> Press  once and  twice.	
<b>3</b> Press  once.	
<b>4</b> Select the paper size: LETTER:  LEGAL: 	The display briefly shows your selection, then: 
<b>5</b> Press  to return to the date and time display.	

## Print contrast setting

Your fax has been set at the factory to print at normal contrast. If desired, you can change the print contrast setting to LIGHT.

<b>1</b> Press  once and  twice.	Display: 
<b>2</b> Press  once and  3 times.	
<b>3</b> Press  once.	
<b>4</b> Select the print contrast: NORMAL:  LIGHT: 	The display briefly shows your selection, then: 
<b>5</b> Press  to return to the date and time display.	

# Entering Your Name and Fax Number

Before you can begin sending faxes, you must enter your name and fax (telephone) number. You also need to set the date and time.



Once you enter this information, it will automatically appear at the top of each fax page you send.



### Important!

FCC regulations require that your name, telephone/fax number, and the date and time appear on each fax message you send. Enter your name and fax number here and set the date and time as explained in the following section to have the fax machine include this information automatically at the top of your fax messages.

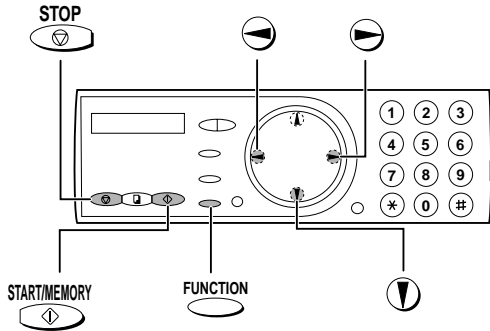

**1** Press **FUNCTION** once and **STOP** 3 times.

Display:

ENTRY MODE

**2** Press **FUNCTION** once.

OWN NUMBER SET

**3** Press **FUNCTION** once.

ENTER FAX #

**4** Enter your fax number by pressing the number keys (max. 20 digits).

- To insert a space between digits, press **#**.
- To clear a mistake, press **SPEAKER**.

**5** Press **START/MEMORY** to enter the fax number in memory.

**6** Enter your name by pressing number keys for each letter as shown in the chart below. Up to 24 characters can be entered.

Example: SHARP = 7777 44 2 777 **▶** 7

SPACE = <b>1</b>	G = <b>4</b>	N = <b>6 6</b>	U = <b>8 8</b>
A = <b>2</b>	H = <b>4 4</b>	O = <b>6 6 6</b>	V = <b>8 8 8</b>
B = <b>2 2</b>	I = <b>4 4 4</b>	P = <b>7</b>	W = <b>9</b>
C = <b>2 2 2</b>	J = <b>5</b>	Q = <b>7 7</b>	X = <b>9 9</b>
D = <b>3</b>	K = <b>5 5</b>	R = <b>7 7 7</b>	Y = <b>9 9 9</b>
E = <b>3 3</b>	L = <b>5 5 5</b>	S = <b>7 7 7 7</b>	Z = <b>9 9 9 9</b>
F = <b>3 3 3</b>	M = <b>6</b>	T = <b>8</b>	

- ◆ To enter two letters in succession that require the same key, press **▶** after entering the first letter.
- ◆ To clear a mistake, press **SPEAKER**.
- ◆ To enter a lower case letter, continue pressing the key for the letter until the lower case letter appears. To enter one of the following symbols, press **#** or **\* (repeatedly)**: . / ! " # \$ % & ' ( ) \* + , - ; < = > ? @ [ ¥ ] ^ \_ ' { | } → ←

**7** Press **START/MEMORY**.

Display:

**DATE&TIME SET** **▶◀**

**8** Press **STOP** to return to the date and time display.

# Setting the Date and Time

The date and time appear in the display and are printed at the top of every page you fax. Set the date and time as shown below.

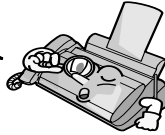

**Do not set the date and time if you are using OpenLCR!**  
 OpenLCR automatically sets the date and time each time your fax calls OpenLCR and receives rate data. To ensure accurate use of the rate data, do not change the date and time setting yourself.

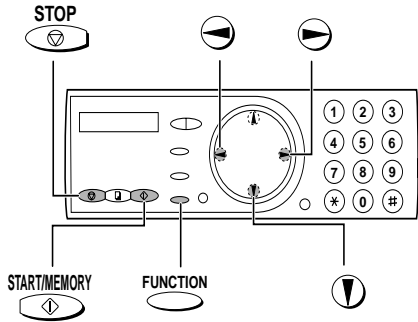

**1** Press **FUNCTION** once and **▼** 3 times. Display: ENTRY MODE

**2** Press **▶** once and **▼** once. DATE&TIME SET

**3** Press **▶**. The currently set date appears (example): DATE 08-15-2002

**4** Enter a two-digit number for the month ("01" for January, "02" for February, "12" for December, etc.).  
 Example: January **0** **1** → DATE 01-15-2002

- To correct a mistake, press **◀** to move the cursor back to the mistake and then enter the correct number.

**5** Enter a two-digit number for the day ("01" to "31").  
 Example: the 5<sup>th</sup> **0** **5** → DATE 01-05-2002

## Setting the Date and Time

### 6 Enter the year (four digits).

Example: 2002     →

The currently set time appears (example):

TIME 12:19 PM

### 7 Enter a two-digit number for the hour ("01" to "12") and a two-digit number for the minute ("00" to "59").

Example: 9:25     →

TIME 09:25 PM

### 8 Press to select A.M. or to select P.M.

### 9 Press to start the clock.

ANTI JUNK # 

### 10 Press to return to the date and time display.

## Daylight Saving Time

If desired, you can set the clock to move forward and backward automatically at the beginning and end of Daylight Saving Time. Follow these steps:

### 1 Press once and twice.

OPTION SETTING 

### 2 Press once and 5 times.

DAY LIGHT SAVE 

### 3 Press once.

1=YES, 2=NO

### 4 Press to select YES, or to select NO.

RECEIVE RATIO 

### 5 Press to return to the date and time display.

## Setting the Reception Mode

Your fax has three modes for receiving incoming faxes:

### FAX mode:

Select this mode when you only want to receive faxes on your line. The fax machine will automatically answer all calls on four rings and receive incoming faxes.

### TEL mode:

Select this mode when you want to receive both phone calls and faxes on the line connected to the fax machine. **All calls, including faxes, must be answered by picking up the fax machine's handset** or an extension phone connected to the same line.

### TAD mode:

Select this mode when you go out and want the answering system to answer all calls. Voice messages will be recorded, and fax messages will be received automatically ("TAD" stands for "Telephone Answering Device".)

## Setting the reception mode

Make sure a document *is not loaded in the document feeder*, and then

press  until the arrow in the display points to the desired mode.

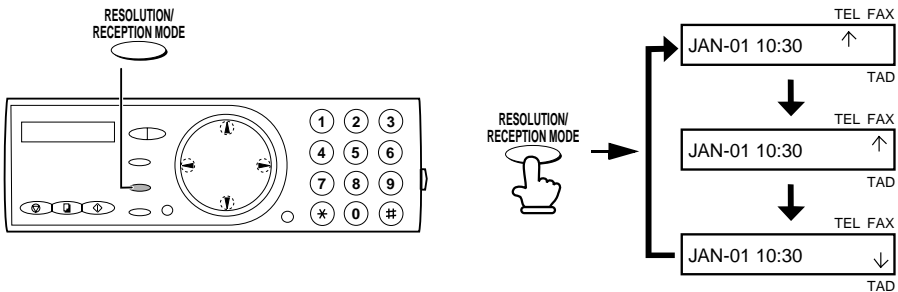

**Note:** TAD mode cannot be selected unless a general outgoing message has been recorded as explained on page 43.

For more information on receiving faxes in FAX and TEL modes, see Chapter 6, *Receiving Faxes*. For more information on using TAD mode, see Chapter 3, *Using the Answering System*.

## Volume Adjustment - Fax Machine

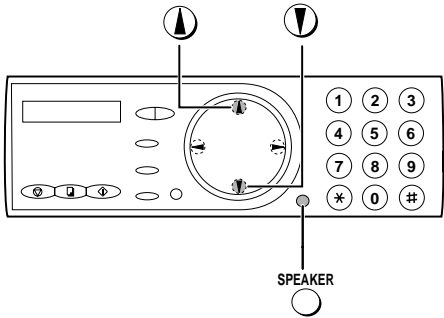

You can adjust the volume of the speaker, handset, and ringer using the up and down arrow keys.

### Speaker

**1** Press **SPEAKER**.

**2** Press **▲** or **▼** until the display shows the desired volume level.

- Press **SPEAKER** again to turn off the speaker.

### Fax machine handset

**1** When talking through the handset, press **▲** or **▼** until the display shows the desired volume level.

- **Note:** The volume reverts to MIDDLE each time you replace the handset.

Display:



RECEIVER: HIGH

RECEIVER: MIDDLE

RECEIVER: LOW



**Fax machine ringer**

- 1** Press  or  until the display shows the desired volume level.  
(Make sure <sup>SPEAKER</sup>  has not been pressed, the handset is not lifted, and a document is not loaded in the feeder.)

- The ringer rings once at the selected level, and then the date and time reappear in the display.

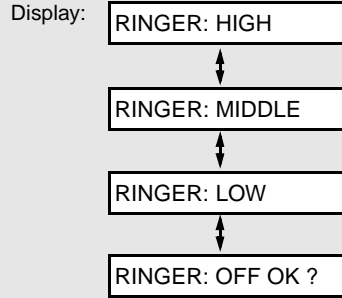

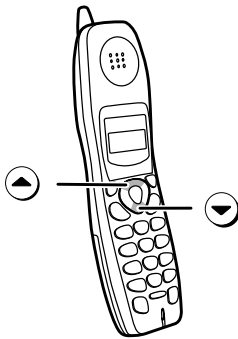

- 2** If you selected “RINGER: OFF OK ?” to turn off the ringer, press <sup>START/MEMORY</sup> .

**Volume Adjustment - Cordless Handset**

You can adjust the volume of the ringer and handset, receiver using the up and down arrow keys.

## ***Cordless handset receiver volume***



**1** When talking on the cordless handset, press  or  until the display shows the desired volume level.

- **Note:** The volume reverts to MIDDLE each time you hang up (press ).

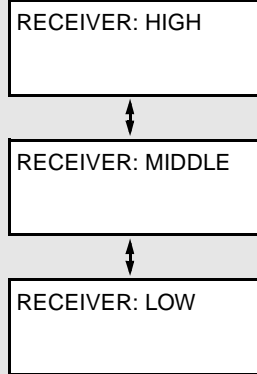
Cordless handset display:





## ***Cordless handset ringer***

**1** When you are not talking on the cordless handset, press  or  until the display shows the desired ringer volume level.

- The ringer will ring once at the selected level.

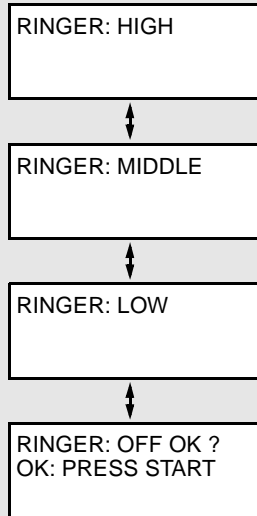
Cordless handset display:



**2** If you selected “RINGER: OFF OK ?” to turn off the ringer, press .

---

## 2. Setting Up and Using OpenLCR

Your fax machine features OpenLCR technology, which helps you save money on long distance and international phone calls (both fax and voice) by automatically routing each call for the best available rate.

- ◆ OpenLCR service is free of charge. The only cost to you is that of a periodic call (usually once every three months) to OpenLCR to receive the latest rate data. (Once you have registered with OpenLCR, your fax machine automatically makes this call.)
- ◆ All calls routed by OpenLCR are consolidated on your monthly phone bill.

To take advantage of this feature, you will need to register with OpenLCR and download the rate data to your fax machine.



You can register with OpenLCR by fax, phone, or through OpenLCR's Web site ([www.OpenLCR.com](http://www.OpenLCR.com)).

- ◆ Before registering, be sure to read the information on the **Fax Transmission Test and OpenLCR Line Activation Form** and **Terms of Service** sheet included with your fax machine. If you have any questions, call OpenLCR at 970-206-1207.
- ◆ OpenLCR uses Caller ID for identification purposes when your fax calls OpenLCR to receive rate information. Even if you have requested your telephone company to withhold your Caller ID information when you place calls, your fax will still automatically transmit this information only when it calls OpenLCR.
- ◆ It is possible to register for and use OpenLCR if you do not subscribe to a Caller ID service; however, in some instances where rate data must be changed on an emergency basis, your fax may not be able to respond automatically to OpenLCR's call to notify your fax that it must receive new rate data. If this occurs, old, incorrect data will continue to be used.
- ◆ Please note that the agreement you enter into by registering is between you and OpenLCR; it is not between you and any carriers.

## Registering by fax

To register by fax, fill in the **Fax Transmission Test and OpenLCR Line Activation Form**, and then fax the form as follows:

- 1 Place the form with the side you wrote on face down, and push it gently into the document feeder of the fax machine.**

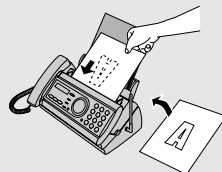

READY TO SEND

- 2 Press , , and then .**

- Your fax automatically calls OpenLCR and sends the form. After the form is sent, your fax will automatically receive the rate data. When downloading is completed, the display will briefly show **DOWNLOAD OK!!** and then revert to the date and time. Your fax will print out the registration form to confirm that it was received.
- OpenLCR will also program the date and time and your fax number in your fax machine.

## Registering by phone

To register by phone, follow these steps:

- 1 Pick up the handset on the fax machine.**

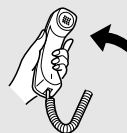

- 2 Press  and then .**

- 3** If the display shows the alternating messages at right, press the number keys to enter your fax/phone number, including the area code (the number must be 10 digits long). When finished,

press  .

(If the message at right doesn't appear, this step is not necessary.)

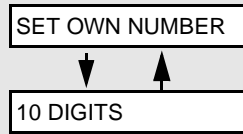

**Important!**

Be sure that you enter your correct area code and fax number. If not, your fax may not dial the correct number to connect to OpenLCR.

- 4** Follow the instructions you hear.

- ◆ If you are on a pulse dial line, press  before pressing the number keys to respond. (This makes your fax temporarily issue tone signals when you press the number keys.)
- ◆ When registration is completed, your fax machine will receive the rate data from OpenLCR. This will last one or two minutes. When downloading is completed, the display will briefly show DOWNLOAD OK!! and then revert to the date and time.
- ◆ OpenLCR will also program the date and time and your fax number in your fax machine.

## Registering through OpenLCR's Web site

You can also register at OpenLCR's Web site, [www.OpenLCR.com](http://www.OpenLCR.com). After registering you will need to receive the rate data manually (service is not activated until your fax receives the rate data). See *Downloading (receiving) the rate data manually* on the following page.



If you move, you must re-register!

The rate data that you receive is based on the address you provide when registering with OpenLCR. If you move, the rate data will not be correct for your new location. In this case, repeat the registration procedure to give OpenLCR your new address.

## Setting Up and Using OpenLCR



**Note:** If you wish to connect more than one OpenLCR-enabled device to the same line, please call OpenLCR at 970-206-1207. If you replace an old OpenLCR-enabled device with a new one, you must re-register with OpenLCR to use the new device.

**Note:** OpenLCR cannot be used if your fax machine is connected to a Private Branch Exchange (PBX).

### ***Downloading (receiving) the rate data manually***

Your fax machine will automatically call OpenLCR and download updated rate data about once every three months. Normally you will not need to download the rate data manually.

- ◆ If you register through OpenLCR's Web site, you must manually download the rate data to activate service.
- ◆ If the fax machine is unplugged or some other interruption occurs in the power, you will need to manually download the rate data.

Press  and  to call OpenLCR and initiate downloading. Downloading lasts one or two minutes. During this time the display will show LCR DOWNLOADING. When downloading is completed, the display will briefly show DOWNLOAD OK!! and then revert to the date and time. OpenLCR will also program the date and time and your fax number in your fax machine.

### ***Using OpenLCR***

When you have registered with OpenLCR and downloaded the rate data to your fax machine, a highlighted "C" will appear in the date and time display to indicate that the OpenLCR feature is activated.

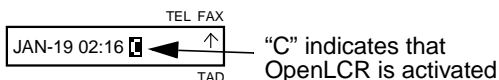

Each time you make a long distance phone or fax call, the fax machine will automatically route the call through the least expensive carrier based on the downloaded rate information.



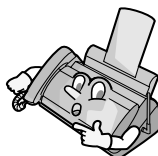



Don't unplug the fax, or the rate data will be lost!



**Caution!** If you unplug the fax machine or an interruption occurs in your power supply, the rate data will be erased. If this happens, the highlighted “C” in the display will blink to alert you. The fax machine will automatically call OpenLCR within the next 24 hours to receive new rate data; however, if you want to use OpenLCR service before that time, you should download the rate table manually as explained on page 36.

- ◆ We recommend that you do not unplug the fax machine on a regular basis (for example at night or on the weekends), as this may result in a large number of calls to OpenLCR and a higher phone bill.











Symbols related to OpenLCR that may appear in the display are shown below.

Mark	Meaning
	OpenLCR has been activated and is ready for use.
 (Blinking)	OpenLCR cannot be used because the rate data has been erased. Your fax will automatically call OpenLCR within the next 24 hours to receive new data, or you can download the data manually if you need to use OpenLCR immediately (see page 36).
	The rate data in the fax is no longer correct and the fax cannot connect to OpenLCR to obtain new data. See <i>What to do if “E” appears in the display</i> on page 39.
	OpenLCR has been temporarily turned off. See <i>Temporarily turning off OpenLCR</i> below.
	Rate data was not yet available when your fax called OpenLCR. Your fax will automatically call OpenLCR again when the rate data is available. Until that time, long distance calls will be routed through your primary carrier.
 (Blinking)	Your fax will automatically call OpenLCR within the next 24 hours to learn when correct rate data will be available.
	Your fax did not receive the rate data because Open LCR was unable to identify your Caller ID. This problem could be noise on the phone line, or because your caller ID signal is blocked. Try retrieving the rate data several more times. If “C” appears, you have retrieved the rate data successfully. If you are still having problems, contact your phone company and make sure they support Caller ID. You can remove the “H” in your display by turning off the Open LCR function (press the <b>OpenLCR</b> key followed by <b>#, 1, 8, 4,</b> and <b>#</b> ). You can also register for OpenLCR by phone to retrieve the rate data (see page 34).

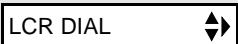
## Temporarily turning off OpenLCR

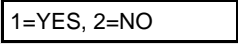





If needed, you can temporarily turn off OpenLCR.

- ◆ When you temporarily turn off OpenLCR, long distance and international calls will not be routed by OpenLCR. However, your fax will still call OpenLCR periodically to receive rate data.







<b>1</b> Press  once and  once.	Display: 
<b>2</b> Press  once.	
<b>3</b> Press  once.	
<b>4</b> Press  (NO) to turn off OpenLCR. (Press  (YES) to turn OpenLCR back on.) <ul style="list-style-type: none"><li>• When you turn off OpenLCR, the highlighted "C" in the display will change to "-".</li></ul>	
<b>5</b> Press  to return to the date and time display.	

## To stop using OpenLCR

If you want to stop using the Open LCR feature, press this sequence of keys:

, , , , , 

- ◆ Calls will not be routed by OpenLCR and the fax machine will not call OpenLCR to update data.

To resume use of OpenLCR, press , , , , , 



## Changing your user profile

If you need to change your user profile, pick up the handset on the fax machine, and then press  followed by **3**. Follow the instructions you hear.

- ◆ If the display shows the alternating messages SET OWN NUMBER / 10 DIGITS, press the number keys to enter your fax/phone number, including the area code (the number must be 10 digits long). When finished, press



- ◆ If you are on a pulse dial line, press **\*** before pressing the number keys to respond to the instructions. (This makes your fax temporarily issue tone signals when you press the number keys.)

## What to do if “E” appears in the display

A highlighted “E” will appear in the display in place of “C” if the rate data in the fax is out-of-date and the fax is unable to obtain new data. When this happens, OpenLCR routing will not take place.

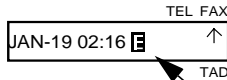

“E” indicates that the rate data is out-of-date.

This will only occur if the fax machine is unable for some reason to make its periodic call to OpenLCR to receive new rate data.

First try downloading the rate data manually by pressing  and **2** as explained in *Downloading (receiving) the rate data manually* on page 36. If this doesn't work, proceed to the following section, *What to do if you cannot connect to OpenLCR*.

## What to do if you cannot connect to OpenLCR

If you are unable to connect to OpenLCR when you use the OpenLCR key to register or manually download data, it is likely that the phone number that the fax machine dials when you press the **OpenLCR** key is no longer correct.

## Setting Up and Using OpenLCR



To obtain the correct phone number, call OpenLCR at 970-206-1207, and then program the number into the fax machine as explained below.

- ◆ **Note:** The number that you will obtain is the number for manually downloading rate data (dialed by pressing the **OpenLCR** key and **2**). When you manually download the rate data, the new numbers for registering (dialed by pressing the **OpenLCR** key and **1, 3, or 5**) will also be programmed in your fax machine.

**1** Press  once and  once.

Display:

LCR SETTING 

**2** Press  once and  once.

CENTER # MODE 

**3** Press  once.

1=SET, 2=CLEAR

**4** Press  (SET) to set the new phone number.

- **Note:** If you wish to restore the factory-set number, press  for CLEAR and then go to Step 6.

**5** Press the number keys to enter the new phone number.

**6** Press  to store the number.

**7** Press  to return to the date and time display.

**8** Press ,  to download new rate data.

- If you have not yet registered with OpenLCR, your fax will receive new phone numbers that will allow you to connect to OpenLCR. Register using one of the procedures described at the beginning of this chapter.

**Note:** The following settings are not required as of the printing of this manual. OpenLCR will inform you through its Web site ([www.OpenLCR.com](http://www.OpenLCR.com)) if the settings become necessary in the future.

## Selecting a long or short call

Before you make a long distance or international phone/fax call, select whether the call will be a long call or a short call.

- ◆ Your fax needs to know whether the call will be long or short to route it for the best rate.

**1** Press  , .

Display:

LCR TABLE SELECT

- **Note:** If the display shows TABLE NOT EXIST, you must first download the rate data.

**2** Press  to select the **SHORT TIME** setting, or  to select the **LONG TIME** setting.

- The initial **SHORT TIME** setting is 2 minutes, and the initial **LONG TIME** setting is 4 minutes. If desired, you can change these settings as explained on the following page.
- The short/long time selection will remain in effect for all calls until you change it.



## Changing the **SHORT TIME** and **LONG TIME** settings

The initial **SHORT TIME** setting is 2 minutes, and the initial **LONG TIME** setting is 4 minutes. If the typical durations of your short and long calls are different, you should change the time settings to ensure that OpenLCR routes your calls for the best rate.

- ◆ For example, if your fax transmissions normally last about 3 minutes and your phone calls last about 5 minutes, set **03** for the **SHORT TIME** and **05** for the **LONG TIME**. Before sending a fax, select the **SHORT TIME** setting (03MIN) in the procedure on the preceding page. Before making a phone call, select the **LONG TIME** setting (05MIN).



## Setting Up and Using OpenLCR

- ◆ When you change the SHORT TIME and/or LONG TIME setting, the fax machine will automatically call OpenLCR and receive rate data for the new times.

**1** Press  once and  once.

Display:

LCR SETTING 

**2** Press  once and  once.

LCR TIME 

**3** Press 

SHORT TIME

**4** Enter a 2-digit number (“01” to “29”) for the number of minutes of the SHORT TIME setting. (If the number is less than 10, enter a 0 before the number.)

The display briefly shows your selection, then:

LONG TIME

**5** Enter a 2-digit number for the number of minutes of the LONG TIME setting. (The number must be greater than the SHORT TIME setting and no more than 30.)

The display briefly shows your selection. If the settings were changed, it will then show:

START: DOWNLOAD

- **Note:** If the display shows NO SERVICE, you must first download the rate data.

**6** Press  to begin receiving the rate data for the new settings.

- Your fax calls OpenLCR and receives the data. This lasts one or two minutes.
- **Note:** If you do not press  to receive new data, the settings will revert to their previous state.

# 3. Using the Answering System

The answering system allows you to receive both voice messages and faxes while you are out.









To use the answering system, you will first need to record an outgoing message. When you go out, turn on the answering system by setting the reception mode to TAD.

## Recording an Outgoing Message

The outgoing message (OGM) is the greeting that the system plays after answering a call to inform callers that they can leave a message or send a fax. Follow the steps below to record a message.

### Example:

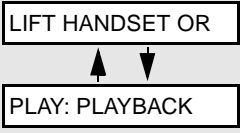
“Hello. You've reached \_\_\_\_\_. No one is available to take your call right now. Please leave a message after the beep or press your facsimile Start key to send a fax. Thank you for calling.”

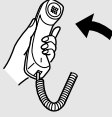
<b>1</b> Press  once and  once.	Display: 
<b>2</b> Press  once.	
<b>3</b> Lift the handset.  (If you have already recorded a message, you can press  to listen to the message.)	

**4** Press  and speak into the handset to record a message.

- The outgoing message can be up to 60 seconds long. While recording, the display will show the time left to record.

**5** When finished, replace the handset or press  .

### ***To listen to the outgoing message***

To listen to the outgoing message, follow Steps 1 and 2 of the above procedure and then press  . Note that the general outgoing message cannot be erased. If you need to change it, simply repeat the recording procedure.

## ***Operating the Answering System***

### ***Activating the answering system***

To turn on the answering system so that callers can leave messages, press

 until the arrow in the display points to TAD. (TAD stands for “Telephone Answering Device”.)

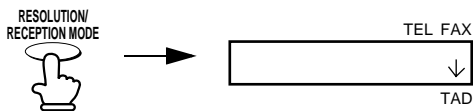

- ◆ The outgoing message will play (you can stop playback by pressing

 ).

- ◆ It will not be possible to set the reception mode to TAD if an outgoing message has not been recorded.

**Note:** In TAD mode, the machine will automatically switch to fax reception if it detects six seconds of silence after answering a call. For this reason, if a caller pauses for this length of time while leaving a message, they will be cut off.

### Number of rings in TAD mode (Toll Saver function)

The number of rings on which the machine answers incoming calls in TAD mode depends on whether the Toll Saver function is turned on, and if it is on, whether you have messages.

- ◆ The Toll Saver function is initially turned on.

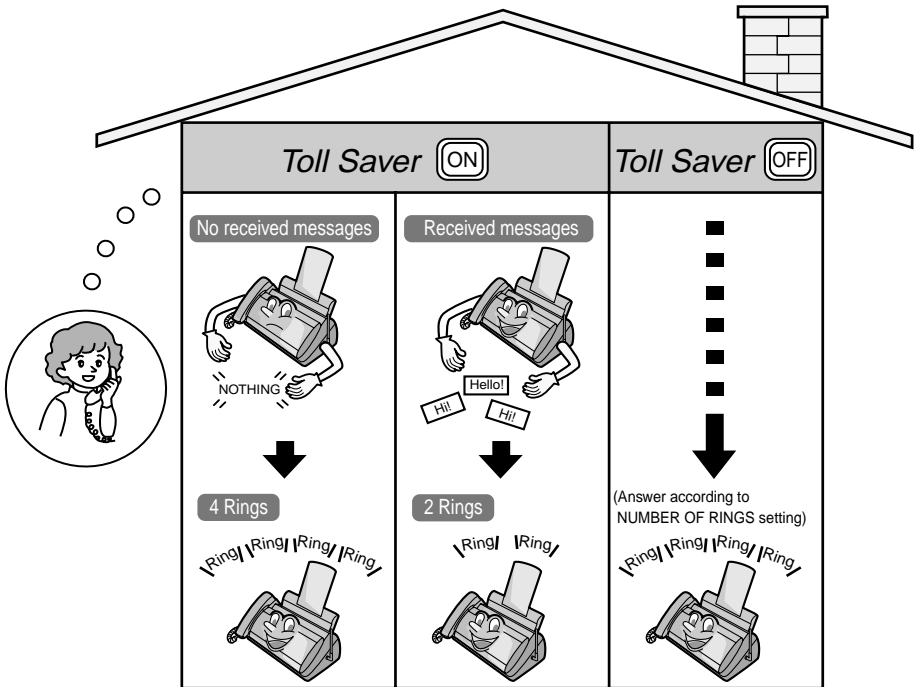

To turn off the Toll Saver function, see page 55.

To adjust the NUMBER OF RINGS setting, see page 87.



## ***Listening to received messages***

When you return, the display will show the number of messages recorded. Follow the steps below to listen to your messages.

### **1 Press .**

- If you only want to listen to new messages (messages not previously listened to), continue to hold  down for at least two seconds.

### **2 The messages will play.**

- As each message plays, the date and time of recording will appear briefly in the display. If no messages were received, NO MESSAGES will appear.
- **Repeat:** To listen to a message a second time, press  before playback of that message ends. To move back to the previous message, press  within 3 seconds of the beginning of the current message.
- **Skip:** To skip forward to the next message, press .





**Note:** Playback will stop if you receive a call, lift the handset, or press .

- ◆ You can print out a list of your received messages that shows the date and time that each was received. See page 103.







## Erasing received messages

It is important to erase received messages after you listen to them to ensure that the memory does not become full.



- ◆ **Erasing all messages:** To erase all messages, press , , and then .
- ◆ **Erasing a single message:** To erase a single message, press  while the message is being played.

## Recording memos

You can record memos for yourself and other users of the machine. These will be played back together with incoming messages when the  key is pressed.

- 1 Press  once and  once.
- 2 Pick up the handset, press , and speak into the handset.
- 3 When you have finished speaking, replace the handset or press .



## Recording phone conversations

To record a phone conversation, hold down the  key during the conversation you want to record. When you are finished, release the key. The conversation will be played back when the  key is pressed.

## Optional Answering System Settings



### Setting ICM time

Incoming messages (ICMs) are the messages which callers leave for you in the answering system. The answering system is set at the factory to allow each caller a maximum of 4 minutes to leave a message. If desired, you can change this setting to 15, 30, or 60 seconds.

**1** Press  once and  once.

Display:

T.A.D. SETTING 

**2** Press  once and  once.

RECORDINGTIME 

**3** Press .

**4** Press a number from 1 to 4 to select the desired ICM recording time.

**1** 15 seconds

**3** 60 seconds

**2** 30 seconds

**4** 4 minutes

The display briefly shows your selection, then:

REMOTE CODE 

**5** Press  to return to the date and time display.











### Fax reception on TAD failure

If the memory for recording incoming messages becomes full while you are out, the answering system will no longer be able to record messages. The ON TAD FAILURE setting is used to choose the response of the machine to incoming calls when this happens:

- ◆ Automatic fax reception NO: The machine will answer after 20 rings, after which it will wait to receive a remote command. Most callers will hang up before it answers; however, when you call the machine from a remote location, you can wait until it answers, listen to your messages, and then erase them (see *Remote Operations* on page 55).







- ◆ Automatic fax reception YES: The reception mode will switch to FAX mode, allowing the machine to continue to receive faxes automatically. With this setting, you can still use the remote commands to listen to your messages and then erase them (see *Remote Operations* on page 55).

Automatic fax reception is set to NO at the factory before shipping. If you want to set it to YES, press the panel keys as follows:



<b>1</b> Press  once and  once.	Display: <div style="border: 1px solid black; padding: 2px; display: inline-block;">T.A.D. SETTING </div>
<b>2</b> Press  once and  twice.	<div style="border: 1px solid black; padding: 2px; display: inline-block;">ON TAD FAILURE </div>
<b>3</b> Press  .	<div style="border: 1px solid black; padding: 2px; display: inline-block;">1=YES, 2=NO</div>
<b>4</b> Press  to turn on automatic fax reception, or  to turn it off.	The display briefly shows your selection, then: <div style="border: 1px solid black; padding: 2px; display: inline-block;">OGM ONLY MODE </div>
<b>5</b> Press  to return to the date and time display.	

### OGM only mode

If needed, you can turn off recording of incoming messages. In this case, your outgoing message will play, but callers will not be able to leave a message. (The machine will still receive faxes sent by automatic dialing.)

<b>1</b> Press  once and  once.	Display: <div style="border: 1px solid black; padding: 2px; display: inline-block;">T.A.D. SETTING </div>
<b>2</b> Press  once and  once.	<div style="border: 1px solid black; padding: 2px; display: inline-block;">OGM ONLY MODE </div>

**3** Press .

**4** Press  to turn on OGM only mode,  
or  to turn it off.

The display briefly shows your selection, then:

TOLL SAVER 

**5** Press  to return to the date and time display.

## Transfer Function



The Transfer function is used to have the machine automatically call you at a specified number every time it receives an incoming message. This lets you hear your messages immediately after they come in, even when you are at a remote location.

To use the Transfer function, you must first program the number that you wish the machine to call (the transfer number), and record the transfer message that plays when you answer the phone at the remote location.

When you go out and wish to use the transfer function, turn it on. When you return and no longer wish to use the transfer function, turn it off.



### Programming the transfer number

To use the Transfer function, you must first give the machine the number to call (the transfer number).

**1** Press  once and  once.

Display:

T.A.D. SETTING 

**2** Press  once and  4 times.

TRANSFER TEL # 

**3** Press .

ENTER TEL #

**4 Press the number keys to enter the transfer number.**

- To insert a pause between any two digits of the number, press .

**5 Press .****6 Press  to return to the date and time display.****Recording the transfer message**



The transfer message plays when you answer the telephone, and informs you that the call is a transfer call. It can be up to 15 seconds long. To record a transfer message, follow the steps below. The following is an example:

“Hello. This is a transfer call for (YOUR NAME). Enter your remote code number now.”

**1 Press  once and  twice.**

Display:

OGM2(TRANSFER) **2 Press  once.****3 Lift the handset.**

(If you have already recorded a message, you can press  to listen to the message, or press  to delete the message.)





**4** Press  and speak into the handset to record the message.

- The transfer message can be up to 15 seconds long. While recording, the display will show the time left to record.

**5** When finished, replace the handset or press  .

### Checking or erasing the transfer message

To check or erase the transfer message, follow Steps 1 and 2 of the above procedure, and then press  to check the message, or  to erase the message.



### Turning the Transfer function on and off

When you go out and wish to use the Transfer function, turn it on as follows:

**1** Press  once and  once.

Display:



T.A.D. SETTING 

**2** Press  once and  3 times.

TRANSFER FUNC 

**3** Press .

1=YES, 2=NO

**4** Press  to turn on the Transfer function.  
(Press  to turn the function off.)

The display briefly shows your selection, then:

ON TAD FAILURE 

**5** Press  to return to the date and time display.

**6** Each time the machine receives an incoming message, it will call your programmed transfer number. When you answer, you will hear your recorded message telling you that the call is a transfer call. On the dial pad of your phone, enter **#**, your remote code number (see page 55), and **#**. The machine will play back your messages.

- You can also perform any of the remote operations described in *Remote Operations* later in this chapter (see page 55).

**Note:** When you hang up after a transfer call, the machine will not immediately resume normal operation. If you want the machine to accept calls immediately after a transfer call, enter **\*** twice before hanging up (if you want to hang up during message playback, first enter **0** and **#** to stop playback, then enter **\*** twice).

## Override Ringing

This function allows selected callers using a touch-tone telephone to override the answering system's outgoing message and cause the machine to make a special ringing sound, alerting you that they are calling. This is useful when you are near the machine but only want to talk with certain callers, taking all other calls on the answering system.

### Programming the override code



To override the answering system, your callers must enter a 3-digit override code from their telephone. This code has been set to "009" at the factory. If you wish to change the code, press the panel keys as shown below.

**Important!** Make sure the override code is different from the remote code used for remote operations.

**1** Press **FUNCTION** once and **▼** once.

Display:

T.A.D. SETTING **↕**

**2** Press  once and  3 times.

OVERRIDE CODE 

**3** Press .

**4** Press the number keys to enter a 3-digit override code.

**5** Press  to store the override code, and then  to return to the date and time display.

### ***Overriding the answering machine***

Your callers should follow the steps below to override the answering system.

**1** The caller calls your machine from a touch-tone telephone. When the outgoing message begins, they should press the  key on their telephone.

- The caller will hear a short beep, and the outgoing message will stop.

**2** The caller should enter the override code and  by pressing the appropriate keys on their telephone.

- If an incorrect code is entered, the caller will hear four beeps. He or she must re-enter the correct code within 10 seconds or the line will be disconnected.

**3** Your machine will make a special ringing sound. Pick up the handset to answer the call.

- If you do not answer within 30 seconds, the outgoing message will play again and the caller can leave a message.



## Remote Operations

When you are out, you can call the machine from any touch-tone telephone and play back your messages using the remote commands. You can also use these commands to change the reception mode and other settings.

### Remote code number

To access the machine to perform remote operations, you must first enter your remote code number. The remote code number has been set to "001" at the factory. If you wish to use a different number, follow these steps:

**1** Press **FUNCTION** once and **▼** once.

Display:

T.A.D. SETTING 

**2** Press **▶** once and **▼** twice.

REMOTE CODE 

**3** Press **▶**.

**4** Press the number keys to enter a 3-digit remote code number.



**5** Press **START/MEMORY** to store the remote number, and then **STOP** to return to the date and time display.

### Toll Saver

When you call the machine to listen to your messages, it will answer after two rings if it has received at least one message, or after four rings if it has not received any messages.

This allows you to save money on telephone charges, particularly if you are calling long distance. If the machine does not answer after the second ring, you can simply hang up before it answers, saving yourself the cost of that call.

If you do not want to use the Toll Saver function, you can turn it off by following the steps below. In this case, the machine will answer after the number of rings set with the NUMBER OF RINGS setting (see *Changing the number of rings* on page 87).

<b>1</b> Press <b>FUNCTION</b> once and <b>▼</b> once.	Display: T.A.D. SETTING 
<b>2</b> Press <b>▶</b> once.	TOLL SAVER 
<b>3</b> Press <b>▶</b> once.	1=YES, 2=NO
<b>4</b> Press <b>1</b> to turn on the Toll Saver function, or <b>2</b> to turn it off.	The display briefly shows your selection, then: RECORDINGTIME 
<b>5</b> Press <b>STOP</b> to return to the date and time display.	

## Retrieving your messages

**1** Call the machine from a touch-tone telephone. When your outgoing message begins, press **#** on the telephone.

- You will hear a short beep, and the outgoing message will stop.

**2** Enter your remote code number and then press **#**.

- You will hear a series of beeps equal to the number of messages recorded, or one long beep if four or more messages have been received. The machine will then play back the messages, beeping once at the end of each message. When all messages have been played back, you will hear a long beep.
- If no messages have been received, you will hear a short beep. You can either hang up, or perform any of the operations described in the following section, *Other remote operations*.

### 3 While the messages are playing, you can do any of the following:

- **Repeat:** To listen to a message a second time, press **2** and **#** on the telephone before that message ends. To move back to the previous message, press **2** and **#** during the first 3 seconds of the current message.
- **Skip forward:** To skip forward to the next message, press **5** and **#** on the telephone.
- **Stop:** To stop playback, press **0** and **#** on the telephone. After this, you can enter any of the commands described in the following section, *Other remote operations*.
- **Play new messages:** To listen to only your new messages, first stop playback by pressing **0** and **#**, and then press **6** and **#**.
- **Erase a message:** To erase the message you are currently listening to, press **3** and **#** before it ends.

### 4 When you have finished listening to your messages, you can do any of the following:

- **Erase all messages:** Press **3**, **3**, and **#**.
- **Repeat playback:** Press **7** and **#**.
- **Perform other operations:** You can enter any of the commands described in the following section, *Other remote operations*.
- **Hang up:** If you do not erase your messages first, they will be saved and any new messages will be recorded after them. If you want the machine to resume normal operation immediately, press **\*** twice before hanging up (in some cases, particularly when the Transfer function is used, the machine may not accept new calls for one or two minutes after you hang up unless you press **\*** twice).

**Note:** You can also call the machine and perform remote operations when the reception mode is set to FAX. In this case, when you call the machine, press

**#** immediately after it answers (before you hear the fax tone), and then continue from Step 2 above.

### Comments:

- ◆ When a remote command is accepted by the machine, you will hear one beep. If an incorrect command is entered, you will hear four beeps. In the latter case, re-enter the correct command.
- ◆ When entering a command, do not pause longer than 10 seconds between each digit. If you do, you will hear a 4-beep error signal and the digits entered up to that point will be cleared. In this case, re-enter the command from the beginning.
- ◆ If you pause for longer than 10 seconds before entering a command, or make two errors while entering your remote code number, the line will be disconnected. (This prevents unauthorized people from attempting to guess your remote code number.)

## Other remote operations

After listening to your messages, you can perform any of the following operations by pressing the appropriate keys on the telephone.

**Note:** The following commands cannot be entered while messages are being played back. If you do not want to wait until playback ends to enter a command, first stop playback by pressing **0** and **#**, and then enter the command.

## Changing the fax reception mode

Select a new reception mode by pressing the keys as follows:

◆ **TAD mode:** **8**, **1**, and **#**.

◆ **FAX mode:** **8**, **2**, and **#**.

◆ **TEL mode:** **8**, **3**, and **#**.

**Caution:** If you select TEL mode, you will not be able to change the reception mode again.

## ***Recording a new outgoing message***

**1** Press **4** and **\*** on the telephone.

**2** When you hear a short beep, speak into the telephone to record the new message.

- The message can be up to 15 seconds long. After 15 seconds (or earlier if the machine detects silence after you finish speaking), you will hear a beep, and the new message will be played back.

## ***Turning the Transfer function on or off***

To turn Transfer on: Press **9**, **1**, and **#** on the telephone.

To turn Transfer off: Press **9**, **2**, and **#** on the telephone.

## ***Changing the transfer telephone number***

**1** Press **9**, **0**, and **#** on the telephone.

**2** After you hear a short beep, enter the new telephone number. When finished, press **#**.

- To insert a pause between any two digits of the number, press **\***.

## ***Recording a new transfer message***

- 1** Press **9**, **3**, and **#** on the telephone.

---

- 2** When you hear a short beep, speak into the telephone to record the new message.
  - The time for the transfer message is fixed at 15 seconds. After 15 seconds (or earlier if the machine detects silence after you finish speaking), you will hear a beep, and the new message will be played back automatically.

## ***Recording a memo***

You can record a memo for yourself or other users of the machine. The memo will be played back when incoming messages are listened to.

- 1** Press **\*** and **#** on the telephone.

---

- 2** When you hear a short beep, speak into the telephone to record the memo.

---

- 3** When you are finished, press **0** and **#** on the telephone.
  - If the machine detects silence, it will stop recording automatically.

## ***OGM only mode***

**To turn on OGM only mode:** Press **1**, **1**, and **#** on the telephone. (Your outgoing message will play, but callers will not be able to record a message. Faxes sent by automatic dialling will be received)

**To turn off OGM only mode:** Press **1**, **2**, and **#** on the telephone.

# 4. Using the Cordless Handset

## Making a Phone Call

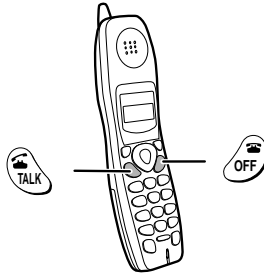

- 1** Pick up the cordless handset and press  .

Cordless handset display:

TALK

- 2** When you hear the dial tone, dial the number.



- 3** When you are ready to end the call, press  .

- You can also end the call by simply placing the cordless handset in the charger.

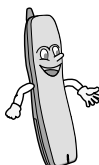



If the display shows FAX BUSY, you must wait until the fax machine is no longer in use to use the cordless handset.

## Receiving a Phone Call



You can also dial by entering the phone number first and then pressing .

Check the number in the display before pressing . If there is a mistake, press  to clear the mistake and then enter the correct digits.

**Note:** If a pause is needed between any of the digits to access an outside line or a special service, press . The pause will appear as a hyphen (-).

## Receiving a Phone Call



**1** When the cordless handset rings, pick it up and press any key (except ) to answer. Talk to the other party.

- If the cordless handset is in the charger, simply pick it up to answer (you do not need to press a key).

**2** When you are ready to end the call, press .

- You can also end the call by simply placing the cordless handset in the charger.

## Putting a Call on Hold

To put the other party on hold during a call, press . The cordless handset will beep while the call is on hold. When you are ready to resume the call, press  once again. Note that placing the cordless handset in the charger will not break the connection while a call is on hold, and thus phone charges may continue to apply.



## Receiving a Fax Using the Cordless Handset

If you hear a fax tone after answering a call on the cordless handset, or if the other party speaks to you and then wants to send a fax, press . This signals the fax machine to begin fax reception.

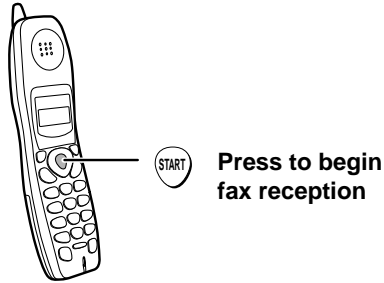

**Note:** If the fax machine detects a fax signal after you answer a call on the cordless handset, it will begin reception automatically.

## Storing and Using Auto-Dial Numbers

You can store your most frequently dialed numbers for automatic dialing.

- ◆ Auto-dial numbers can be stored using either the cordless handset or the fax machine (to store a number using the fax machine, see page 78).
- ◆ The cordless handset and fax machine share the same auto-dial numbers. A total of 30 numbers can be stored.

1 Press  SEARCH .



Cordless handset display:

SEARCH DIAL  
▲▼: SEARCH  
FUNCTION: ENTRY

2 Press  .

ENTER TEL #

























































**3 Enter the number by pressing the number keys.**  
 (Note: A space cannot be entered.)

- To clear a mistake, press  .
- If a pause is required between any of the digits to access a special service or an outside line, press  . The pause appears as a hyphen (two seconds per pause). Several pauses can be entered in a row.

**4 Press .**

**5 Enter a name by pressing number keys for each letter as shown in the chart below. Up to 15 characters can be entered. (If you do not wish to enter a name, go directly to Step 6.)**

Example: SHARP = 7777 44 2 777  7

SPACE = 	G = 	N =  	U =  
A = 	H =  	O =   	V =   
B =  	I =   	P = 	W = 
C =   	J = 	Q =  	X =  
D = 	K =  	R =   	Y =   
E =  	L =   	S =    	Z =    
F =   	M = 	T = 	

- ◆ To enter two letters in succession that require the same key, press  after entering the first letter.

- ◆ To clear a mistake, press  .

- ◆ To enter a lower case letter, continue pressing the key for the letter until the lower case letter appears. To enter one of the following symbols, press

 or  repeatedly:

. / ! " # \$ % & ' ( ) \* + , - : ; < = > ? @ [ \ ] ^ \_ ' { | } → ←

**6** Press .

SEARCH DIAL  
▲▼: SEARCH  
FUNCTION: ENTRY

**7** Return to Step 2 to store another number, or press  to exit.

## Dialing an auto-dial number

**1** Press  SEARCH once.

SEARCH DIAL  
▲▼: SEARCH  
FUNCTION: ENTRY

**2** Press  or  until the number you wish to dial appears in the display.

**3** Press .



- The number is automatically dialed.

## Editing an auto-dial number

If you need to make changes to a previously stored auto-dial number, follow these steps:



**1** Press  SEARCH once.

SEARCH DIAL  
▲▼: SEARCH  
FUNCTION: ENTRY

**2** Press  or  until the number you wish to edit appears in the display.

**3** Press  once.

### 4 Press the number keys to enter the new number.

- To clear a mistake, press . If a pause is required between any of the digits to access a special service or an outside line, press  ..
- If you do not wish to change the number, go directly to Step 5.

### 5 Press .

### 6 Press the number keys to enter the new name (see Step 5 on page 64).

- If you do not wish to change the name, go directly to Step 7.

### 7 Press .

SEARCH DIAL  
▲▼: SEARCH  
FUNCTION: ENTRY

### 8 Press to exit.

## Clearing an auto-dial number

If you need to clear an auto-dial number, follow these steps:

### 1 Press SEARCH once.

SEARCH DIAL  
▲▼: SEARCH  
FUNCTION: ENTRY

### 2 Press or until the number you wish to clear appears in the display.

3 Press  .

ERASE?  
PRESS START KEY

4 Press  .

SEARCH DIAL  
▲▼: SEARCH  
FUNCTION: ENTRY

5 Press  to exit.

## Redial

You can automatically redial the last number dialed on the cordless handset.

**Note:** The fax machine and the cordless handset each retain their own separate redial numbers.

1 Press  .

- Check the display to make sure the number that appears is the number you wish to dial. (If the wrong number appears, press  to clear it.)

2 Press  . The number is automatically dialed.

**Note:** You can also redial by pressing  first and then  . Note that this method does not allow you to check the number before dialing begins.

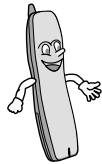

## Using the Intercom Feature



You can use the cordless handset and the fax machine handset as an intercom.

**Note:** When using the Intercom feature, you will not hear your voice through the handset receiver when you speak.

### Paging the fax machine from the cordless handset

- 1 Press  and then  on the cordless handset.

Cordless handset display:

INTERCOM

- 2 The fax machine makes a special ringing sound.

Fax machine display:

INTERCOM

- 3 The other person picks up the fax machine handset to answer.

- 4 Talk with the other person. When you are ready to end the conversation, press .

### Paging the cordless handset from the fax machine (cordless handset locator)

You can use this procedure to page the cordless handset, or locate the handset in the event that you misplace it.

- 1 Press  on the fax machine, and then pick up the handset.

Fax machine display:

INTERCOM

## 2 The cordless handset makes a special ringing sound.

- This allows you to locate the cordless handset if you have misplaced it.

Cordless handset display:

INTERCOM

## 3 The other person presses any key (except ) on the cordless handset to answer.

## 4 Talk with the other person. When you are ready to end the conversation, replace the handset.

### *If a call comes in while the Intercom feature is being used*

If an outside call comes in while you are using the Intercom feature, the person who wishes to take the call should first stop the Intercom call (press



on the cordless handset or replace the fax machine handset), and then

answer the outside call (press any key except ) on the cordless handset or pick up the fax machine handset).

## **Transferring Calls**

You can transfer a call from the cordless handset to the fax machine, or from the fax machine to the cordless handset.

### ***Transferring a call from the cordless handset to the fax machine***

## 1 During the call, press on the cordless handset.

Cordless handset display:

INTERCOM



## 2 The fax machine makes a special ringing sound.

Fax machine display:

INTERCOM

**3** The other person picks up the fax machine handset to answer.

**4** Tell the person who answers that you are transferring the call, and then press .

- Note that if you press  before the other person answers on the fax machine, the call will be disconnected.
- If no one answers when you page the fax machine, press  once again to return to the initial caller.

### ***Transferring a call from the fax machine to the cordless handset***

**1** During the call, press  on the fax machine.

Fax machine display:

INTERCOM

**2** The cordless handset makes a special ringing sound.

Cordless handset display:

INTERCOM

**3** The other person presses any key (except ) on the cordless handset to answer.

**4** Tell the person who answers that you are transferring the call, and then replace the fax machine's handset.

- Note that if you replace the handset before the other person answers on the cordless handset, the call will be disconnected.
- If no one answers when you page the cordless handset, press  once again to return to the initial caller.



## Using REMOTE MODE

You can use the cordless handset to change the reception mode on the fax machine, and listen to messages received in the answering system.

### Changing the reception mode on the fax machine

**1** Press .

Cordless handset display:

REMOTE MODE

**2** Press  until the desired reception mode appears in the display.

Example: FAX mode

RECEPTION  
FAX

**3** Press  or  to exit REMOTE MODE.

### Listening to messages received in the answering system

You can use the cordless handset to listen to messages received in the answering system.

- ◆ The answering system is explained in detail in Chapter 3.
- ◆ When you have received new messages in the answering system, NEW MESSAGES appears in the cordless handset display.

**1** Press .

Cordless handset display:

REMOTE MODE

**2** Press  to listen to all your messages, or  to listen to only your new messages.

**3 While listening to your messages, you can do any of the following:**

- **Repeat:** To repeat a message, press .
- **Skip:** To skip forward, press .
- **Delete:** To delete the message you are currently listening to, press .
- **Stop:** To stop playback, press .

**4 To return to the STAND-BY display, press  or .**

- If a call comes in while you are listening to your messages, playback will stop automatically. Press any key to answer.
- If you take no action for 30 seconds in REMOTE MODE, the cordless handset will automatically return to the STAND-BY display.

**Deleting all messages from the answering system**



**1** Press  .  
(Note: This step is not necessary if you are already in REMOTE mode.)

Cordless handset display:

REMOTE MODE

**2** Press  .

REMOTE MODE  
DELETE ALL?  
PRESS START KEY

**3** Press  to delete the messages, and then  or  to return to the STAND-BY display.

- To cancel, press , , or .

# 5. Sending Faxes

## Transmittable Documents

### Size and weight

The size and weight of documents that you can load in the document feeder depend on whether you load one page at a time or several pages at once.

Loading one page at a time:		Loading up to 10 pages at once:	
Minimum size	Maximum size	Minimum size	Maximum size
Minimum weight	Maximum weight	Minimum weight	Maximum weight
<div style="border: 1px solid black; padding: 5px; text-align: center;"> <b>14 lbs.</b>  <b>(52 g/m<sup>2</sup>)</b> </div>	<div style="border: 1px solid black; padding: 5px; text-align: center;"> <b>42 lbs.</b>  <b>(157 g/m<sup>2</sup>)</b> </div>	<div style="border: 1px solid black; padding: 5px; text-align: center;"> <b>14 lbs.</b>  <b>(52 g/m<sup>2</sup>)</b> </div>	<div style="border: 1px solid black; padding: 5px; text-align: center;"> <b>21.5 lbs.</b>  <b>(80 g/m<sup>2</sup>)</b> </div>

**Note:** Letters or graphics on the edges of a document will not be scanned.

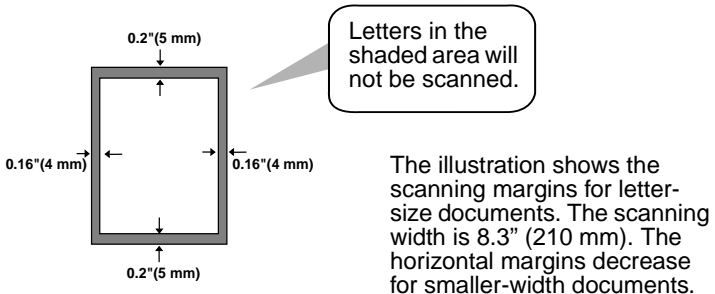

## ***Other restrictions***

- ◆ The scanner cannot recognize yellow, greenish yellow, or light blue ink.
- ◆ Ink, glue, and correcting fluid on documents must be dry before they pass through the document feeder.
- ◆ All clips, staples, and pins must be removed from documents before loading in the feeder. If these are not removed, they may damage the machine.
- ◆ Documents which are patched, taped, torn, smaller than the minimum size, carbon backed, easily smudged, or have a slippery coated surface should be photocopied, and the copy loaded in the feeder.

## ***Loading the Document***

Up to 10 pages can be placed in the feeder at one time. The pages will automatically feed into the machine starting from the bottom page.

- ◆ If you need to send or copy more than 10 pages, place the additional pages gently and carefully in the feeder just before the last page is scanned. Do not try to force them in, as this may cause double-feeding or jamming.
- ◆ If your document consists of several large or thick pages which must be loaded one at a time, insert each page into the feeder as the previous page is being scanned. Insert gently to prevent double-feeding.

- 
- 1** Adjust the document guides to the width of your document.

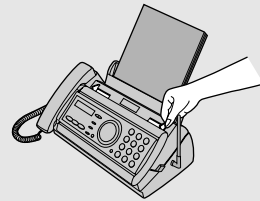

- 
- 2** Insert the document face down in the document feeder. The top edge of the document should enter the feeder first.

- READY TO SEND will appear in the display.

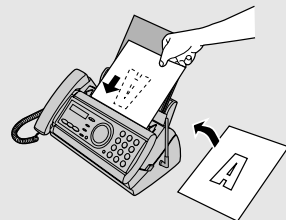

- 3** Adjust the resolution and/or contrast settings as explained in *Resolution and Contrast* below, then dial the receiving machine as explained on page 76.

## Adjusting the Resolution and Contrast

If desired, you can adjust the resolution and contrast before sending a document.

The default resolution setting is STANDARD and the default contrast setting is AUTO.



You must adjust the settings each time you don't want to use the default settings.



**Note:** The resolution and contrast settings are only effective for sending a document. They are not effective for receiving a document.

### Resolution settings

STANDARD	Use STANDARD for ordinary documents. This setting gives you the fastest and most economical transmission.
FINE	Use FINE for documents containing small letters or fine drawings.
SUPER FINE	Use SUPER FINE for documents containing very small letters or very fine drawings.
HALF TONE	Use HALF TONE for photographs and illustrations. The original will be reproduced in 64 shades of gray.

## Contrast settings

AUTO

Use AUTO for normal documents.

DARK

Use DARK for faint documents.

### 1 Load the document(s).

- The document must be loaded before the resolution and contrast can be adjusted.

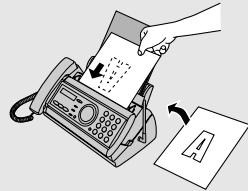

### 2 Press **RESOLUTION/RECEPTION MODE** one or more times until the desired resolution and contrast settings appear in the display.

- The first time you move through the list of resolution settings, the contrast setting AUTO will appear next to each resolution setting. The second time you move through the list, the contrast setting DARK will appear.

Display:

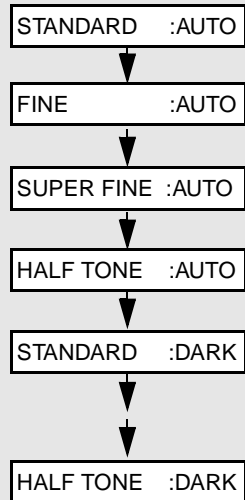

**Note:** In order to transmit in SUPER FINE resolution, the receiving fax machine must also have that resolution. If it doesn't, your machine will automatically step down to the next best available setting.

## Sending a Fax by Normal Dialing

With Normal Dialing, you pick up the handset (or press ) and dial by pressing the number keys.

- ◆ If a person answers, you can talk with them through the handset before sending the fax. (If you pressed , you must pick up the handset to talk.)
- ◆ Normal Dialing allows you to listen to the line and make sure the other fax machine is responding.

### 1 Load the document(s).

- If desired, press  to set the resolution and/or contrast.

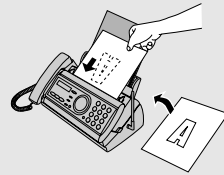

READY TO SEND

### 2 Pick up the handset or press . Listen for the dial tone.



or



### 3 Dial the number of the receiving machine by pressing the number keys.



### 4 Wait for the connection. Depending on the setting of the receiving machine, you will either hear a fax tone or the other person will answer.

- If the other party answers, ask them to press their Start key (if you pressed , pick up the handset to speak with them). This causes the receiving machine to issue a fax tone.

**5** When you hear the fax tone, press . Replace the handset if you used it.

- When transmission is completed, the fax will beep once.



**Note:** If the transmission is unsuccessful and DOCUMENT JAMMED appears in the display, remove the document as explained on page 123. (This may occur if the other fax machine doesn't respond properly when you attempt to send the document.)

## ***Sending a Fax by Automatic Dialing***

You can store your most frequently dialed fax or phone numbers in the machine for automatic dialing.

- ◆ Auto-dial numbers can be stored using either the fax machine or the cordless handset (to store a number using the cordless handset, see page 63).
- ◆ The cordless handset and fax machine share the same auto-dial numbers. A total of 30 numbers can be stored.

## ***Storing fax and phone numbers for automatic dialing***

**1** Press  once and  once.



Display:

<NEW NUMBER> 

**2** Press  once.

ENTER FAX #

**3** Enter the fax or voice number by pressing the number keys.  
(Note: A space cannot be entered.)

- To clear a mistake, press .
- If a pause is required between any of the digits to access a special service or an outside line, press . The pause appears as a hyphen (two seconds per pause). Several pauses can be entered in a row.



**4** Press  .



**5** Enter a name by pressing number keys for each letter as shown in the chart below. Up to 15 characters can be entered. (If you do not wish to enter a name, go directly to Step 6.)

Example: SHARP = 7777 44 2 777  7

SPACE = (1)	G = (4)	N = (6) (6)	U = (8) (8)
A = (2)	H = (4) (4)	O = (6) (6) (6)	V = (8) (8) (8)
B = (2) (2)	I = (4) (4) (4)	P = (7)	W = (9)
C = (2) (2) (2)	J = (5)	Q = (7) (7)	X = (9) (9)
D = (3)	K = (5) (5)	R = (7) (7) (7)	Y = (9) (9) (9)
E = (3) (3)	L = (5) (5) (5)	S = (7) (7) (7) (7)	Z = (9) (9) (9) (9)
F = (3) (3) (3)	M = (6)	T = (8)	

◆ To enter two letters in succession that require the same key, press  after entering the first letter.

◆ To enter a lower case letter, continue pressing the key for the letter until the lower case letter appears. To enter one of the following symbols, press

 or  repeatedly: . / ! " # \$ % & ' ( ) \* + , - : ; < = > ? @ [ ¥ ] ^ \_ ' { | } → ←

**6** Press  .

Display:



**7** Return to Step 2 to store another number, or press  to return to the date and time display.

**Note:** The fax machine uses a lithium battery to keep automatic dialing numbers and other programmed information in memory when the power is turned off. Battery power is consumed primarily when the power is off. With the power kept continuously off, the life of the battery is about 5 years. If the battery dies, have your dealer or retailer replace it. Do not try to replace it yourself.



## Editing and clearing auto-dial numbers

If you need to make changes to a previously stored auto-dial number, or clear a number, follow these steps:

**1** Press **FUNCTION** once and  once.

Display:

<NEW NUMBER> 

**2** Press  or  until the number you wish to edit or clear appears in the display.



**3** Press .

1=EDIT, 2=CLEAR

**4** Press **1** for EDIT or **2** for CLEAR.



- If you selected CLEAR, go to Step 8.

**5** If you selected EDIT, make the desired changes to the number.

- Press  or  to move the cursor to the digit or digits you wish to change, and then enter the new digit. The new digit will replace the old digit.
- If you do not wish to change the number, go directly to Step 6.

**6** Press **START/MEMORY** .

**7** Make the desired changes to the name.

- Press  or  to move the cursor to the letter or letters you wish to change, and then press the appropriate number key repeatedly until the desired letter appears (see Step 5 on page 79). The new letter will replace the old letter.
- If you do not wish to change the name, go directly to Step 8.

**8** Press **START/MEMORY** .

**9** Return to Step 2 to edit or clear another number, or press **STOP**  to return to the date and time display.



### Using an auto-dial number

Once you have stored a fax or phone number, you can use it to send a fax or make a phone call.

**1** If you are sending a fax, load the document(s).

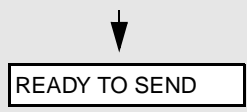
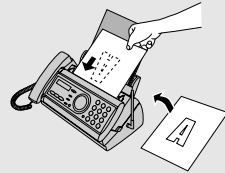
- If desired, press **RESOLUTION/RECEPTION MODE**  to set the resolution and/or contrast.



**2** Press  (or ) until the name of the other party appears in the display (if no name was stored, the number will appear).

**3** If you are sending a fax, press **START/MEMORY** . Dialing and transmission begins.

If you are making a phone call, lift the handset. Dialing begins.

## ***Sending a fax by Direct Keypad Dialing***

You can also enter a full number with the number keys and then press the **START/MEMORY**  key to begin dialing. You can use this method to dial a full number when you don't need to speak to the other party before faxing.

### **1 Load the document(s).**

- If desired, press **RESOLUTION/RECEPTION MODE**  to set the resolution and/or contrast.

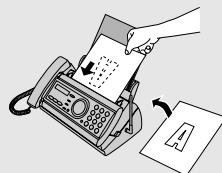

**READY TO SEND**

### **2 Enter the number of the receiving machine by pressing the number keys.**

- If a pause is required between any of the digits to access a special service or an outside line, press **FUNCTION** . The pause will appear as a hyphen (two seconds per pause). Several pauses can be entered in a row.

### **3 Check the display. If the number of the receiving machine shown is correct, press **START/MEMORY** .**

- If the number is not correct, press **STOP**  to backspace and clear one digit at a time, and then re-enter the correct digit(s).

## Redial

You can automatically redial the last number dialed on the fax machine. This procedure can be used to send a fax or make a phone call.

**Note:** The fax machine and the cordless handset each retain their own separate redial numbers.

### 1 If you are sending a fax, load the document(s).

- If desired, press  to set the resolution and/or contrast.

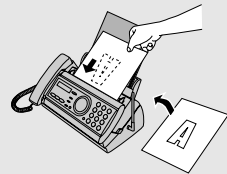

### 2 Press once. <REDIAL> appears in the display, followed by the last number dialed. Make sure the number that appears is the number you wish to dial.

### 3 If you are sending a fax, press . Dialing begins.

If you are making a phone call, lift the handset. Dialing begins.

**Note:** If a fax transmission is unsuccessful and DOCUMENT JAMMED appears in the display, remove the document as explained on page 123. (This may occur if the other fax machine doesn't respond properly when you attempt to send the document.)

## Automatic redialing

If you use automatic dialing (including Direct Keypad Dialing) to send a fax and the line is busy, the fax machine will automatically redial the number. The fax machine will make three redial attempts at intervals of five minutes. During this time, RECALLING will appear in the display, followed by a two-digit number assigned to the fax job. You will not be able to dial any other locations while the message appears.



## Sending a Fax by Automatic Dialing

- ◆ You can press  to clear the message and stop automatic redialing.
- ◆ Under certain conditions (for example if a person answers the call on a telephone), automatic redialing may stop before three redialing attempts are made.



## Error Correction Mode

The fax machine is set to automatically correct any distortions in a transmission due to noise on the telephone line before printing at the receiving end. This function is called Error Correction Mode (ECM). ECM is effective for both transmissions and receptions, and is only effective when the other fax machine has ECM as well.

If desired, you can turn ECM off. This will increase slightly the amount of memory available for memory transmission and reception.

**1** Press  once and  twice.

OPTION SETTING 

**2** Press  once and  6 times.

ECM MODE 

**3** Press  once.

1=YES, 2=NO

**4** Press  to select YES, or  to select NO.

The display briefly shows your selection, then:

DAY LIGHT SAVE 

**5** Press  to return to the date and time display.

## Sending a Fax From Memory

You can scan a document into the fax's memory and send the document from memory. This increases transmission speed and allows you to send a fax to multiple destinations in a single operation. After transmission, the document is automatically cleared from memory.

**Note:** If a power failure occurs while sending a fax from memory, you will need to repeat the operation.

### Broadcasting (sending a fax to multiple destinations)

This function allows you to send the same fax to as many as 20 different destinations in just one operation.

- ◆ When sending to multiple destinations, only auto-dial numbers can be used to dial the numbers of the receiving machines.

#### 1 Load the document(s).

- If desired, press **RESOLUTION/RECEPTION MODE** to set the resolution and/or contrast.

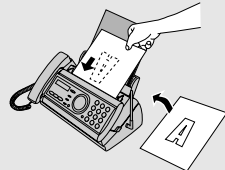

#### 2 Press **START/MEMORY**.

#### 3 Press **▶** (or **◀**) until the name of the destination appears in the display (if no name was stored, the number will appear).

#### 4 Press **▼** to select the destination.

#### 5 Repeat Steps 3 and 4 for each of the other destinations to which you wish to send the fax (maximum of 20).

- To check your selected destinations, press **▲** to scroll through them. To delete a destination, scroll to the destination and then press **STOP**.





**6** When you are ready to begin transmission, press  .

- A Transaction Report is automatically printed out after Broadcasting is completed. Check the "Note" column of the report to see if any of the destinations are marked "Busy" or have a communication error code. If so, send the document to those destinations again.

## ***Memory transmission***



You can also send a fax through memory when sending to a single destination. This is convenient when sending to destinations where the line is often busy, as it saves you from waiting to pick up the original document and frees the feeder for other operations.

To send a fax through memory, load the document, press  , and then dial using one of the following methods:

- ◆ Press the number keys to enter the fax number and then press  .
- ◆ Press  repeatedly to select an auto-dial number and press  .
- ◆ Press  once to select the last number dialed and press  .

## ***If the memory becomes full...***

If the memory becomes full while the document is being scanned, MEMORY IS FULL and SEE MANUAL will alternately appear in the display.

- ◆ Press  if you want to transmit the pages which have been stored up to that point in memory. The remaining pages will be ejected from the feeder. After transmission, the memory will be cleared and you can transmit the remaining pages. You will also need to transmit the page which was being scanned when the memory filled up.
- ◆ Press  if you want to cancel the entire transmission.



## 6. Receiving Faxes

### Using FAX Mode

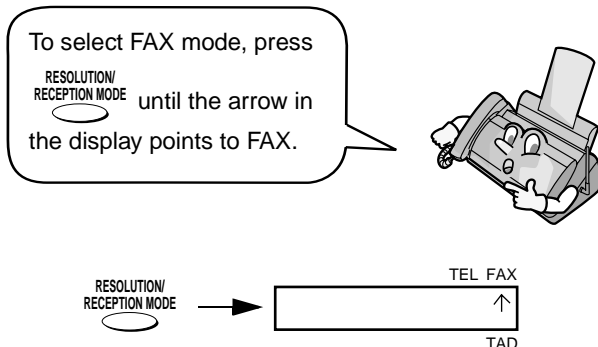

When the reception mode is set to FAX, the fax machine will automatically answer all calls on four rings and receive incoming faxes.

- ◆ If you pick up the handset before the machine answers, you can talk to the other party and/or receive a fax as explained in *Using TEL Mode* on page 88.

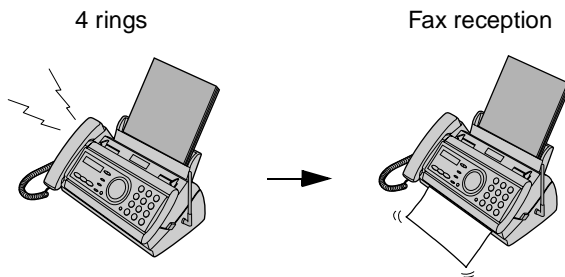

### Changing the number of rings

If desired, you can change the number of rings on which the fax machine answers incoming calls in FAX mode. Any number from 2 to 5 can be selected.

**1** Press **FUNCTION** once and **▲** twice.

Display:

OPTION SETTING ◀▶

**2** Press  once.

NUMBER OF RING 

**3** Press  once.

ENTER (2-5) (4)

**4** Enter the desired number of rings (any number from 2 to 5).

The display briefly shows your selection, then:

Example: 3 rings 

TRANSACTION 

**5** Press  to return to the date and time display.

Note: If you are using Distinctive Ring, the fax machine will answer calls after two rings regardless of the above setting.

## Using TEL Mode



To select TEL mode, press  until the arrow in the display points to TEL.

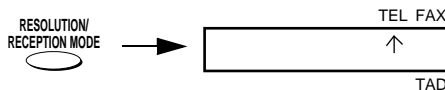

When the reception mode is set to TEL, you must answer all calls by picking up the fax machine's handset or an extension phone connected to the same line.

## Answering with the fax's handset

- 1** When the fax machine rings, pick up the handset.



- 2** If you hear a fax tone, wait until the display shows **RECEIVING** and then replace the handset.



→ **RECEIVING**

**Note:** If you have set the Fax Signal Receive setting to NO, press **START/MEMORY**  to begin reception.

- 3** If the other party first speaks with you and then wants to send a fax, press **START/MEMORY**  after speaking. (Press before the sender presses their Start key.)

**START/MEMORY**  → **RECEIVING**

- When **RECEIVING** appears in the display, hang up.



## Answering on an extension phone connected to the same line

- 1** Answer the extension phone when it rings.



## Optional Reception Settings

- 2** If you hear a soft fax tone, wait until your fax responds (you will hear pronounced, high-pitched tones), then hang up.

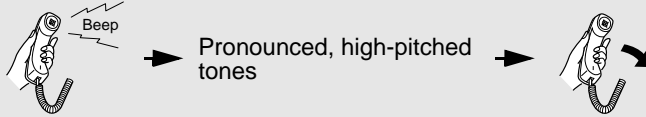

- 3** If the fax doesn't respond, or if the other party first talks to you and then wants to send a fax, set the phone down (do not hang up), walk over to the fax, lift the fax's handset, and press  .

- The above step is necessary if you have set the Fax Signal Receive setting to NO.

## Optional Reception Settings



### Fax Signal Receive

Your fax will automatically begin reception if you hear a soft fax tone after answering a call on your fax or an extension phone. If you use a computer fax modem to send documents on the same line, you must turn this function off in order to prevent your fax from mistakenly attempting to receive documents from the computer fax modem. Follow the steps below to change the setting.

- 1** Press  once and  twice.

Display:



OPTION SETTING 

- 2** Press  once and  4 times.

FAX SIGNAL RX 

- 3** Press  once.

1=YES, 2=NO

- 4** Press  to turn on the function, or  to turn it off.

The display briefly shows your selection, then:

CALLER-ID 

- 5** Press  to return to the date and time display.

## Reception Ratio



The fax has been set at the factory to automatically reduce the size of received documents to fit the size of the printing paper. This ensures that data on the edges of the document are not cut off. If desired, you can turn this function off and have received documents printed at full size.

- ◆ If a document is too long to fit on the printing paper, the remainder will be printed on a second page. In this case, the cut-off point may occur in the middle of a line.
- ◆ Automatic reduction may not be possible if the received document is too large, contains too many fine graphics or images, or is sent at high resolution. In this case, the remainder of the document will be printed on a second page.

- 1** Press  once and  twice.

Display:



OPTION SETTING 

- 2** Press  once and  4 times.

RECEIVE RATIO 

- 3** Press  once.

1=AUTO, 2=100%

- 4** Press  to select AUTO, or  to select 100%.

The display briefly shows your selection, then:

PRINT CONTRAST 

**5** Press  to return to the date and time display.

## ***Substitute Reception to Memory***

In situations where printing is not possible, such as when your fax runs out of paper, the imaging film needs replacement, or the paper jams, incoming faxes will be received to memory.

When you have received a document in memory, FAX RX IN MEMORY will appear in the display, alternating with ADD PAPER & PRESS START KEY or CHECK FILM / CHECK COVER / CHECK PAPER JAM. When you add paper (and press ), replace the imaging film, or clear the jam, the stored documents will automatically print out.

- ◆ If you received documents in memory because the fax ran out of paper, be sure to add paper which is the same size as the paper previously used. If not, the document print-out size may not match the size of the printing paper.

## 7. Making Copies

Your fax machine can also be used to make copies. Single and multiple copies (up to 99 per original) can be made, enabling your fax to double as a convenience office copier.

### 1 Load the document(s) face down. (Maximum of 10 pages.)

- If desired, press **RESOLUTION/RECEPTION MODE** to set the resolution and/or contrast. (The default resolution setting for copying is FINE.)

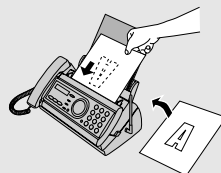

READY TO SEND

### 2 If desired, select an enlarge/reduce setting, and/or select the number of copies per original:

- ENLARGE/REDUCE: Press or until the desired setting appears in the display. Settings are 100%, 125%, 135%, 50%, 73%, 88%, 94%, and AUTO (auto size adjustment to match the size of the paper). The default setting is 100%.

Example: Press twice → **RATIO: 125%**

- Number of copies per original: Press the number keys to enter a number from 1 to 99. The default setting is 1.

Example: Press for five copies → **5**

### 3 When you are ready to begin copying, press **COPY/HELP**.

#### If MEMORY IS FULL appears...

If the memory becomes full while a document is being scanned, MEMORY IS FULL and SEE MANUAL will alternately appear in the display and the document will automatically feed out. This may happen if the resolution is set to SUPER FINE, or if you selected an enlarge/reduce setting, or if you are making more than one copy per original. To avoid using memory, use STANDARD or FINE for the resolution, 100% for the enlarge/reduce setting, and make only one copy per original.

## Copy Cut-off

When making a copy of a document that is longer than the printing paper, use the copy cut-off setting to select whether the remaining part of the document will be cut off or printed on a second page. The initial setting is YES (cut off the remainder). To change the setting, follow the steps below.

**1** Press **FUNCTION** once and **▲** twice.

Display:

OPTION SETTING 

**2** Press **▶** once and **▲** once.

COPY CUT-OFF 

**3** Press **▶** once.

1=YES, 2=NO

**4** Press **1** to set copy cut-off to YES (the remaining part of the document will not be printed), or **2** to set copy cut-off to NO (the remaining part will be printed on a second page).

The display briefly shows your selection, then:

NUMBER OF RING 

**5** Press **STOP** to return to the date and time display.



## 8. Special Functions

### Caller ID (Requires Subscription to Service)

If you subscribe to a caller identification service from your telephone company, you can have the fax machine and the cordless handset display the name and number of the caller when you receive a call.

**Important:**

- ◆ To use this function, you must subscribe to a caller identification service from your telephone company.
- ◆ Your fax may not be compatible with some caller identification services.

**1** Press **FUNCTION** once and **▲** twice on the fax machine.

Display:

OPTION SETTING 

**2** Press **▶** once and **▼** 5 times.

CALLER-ID 

**3** Press **▶** once.

1=YES, 2=NO

**4** Press **①** (YES) to turn on Caller ID.  
(To turn off Caller ID, press **②** and go to Step 8.)

AREA CODE # MODE



1=SET, 2=CLEAR

**5** Press **①** to select SET.  
(To clear a previously programmed area code, press **②** and go to Step 8.)

ENTER AREA CODE

**6** Enter the three digits of your area code.

## Caller ID (Requires Subscription to Service)

**7** Press  to store your area code.

ECM MODE 

**8** Press  to return to the date and time display.

### ***How Caller ID operates***

When you receive a call, the name and phone number of the caller will appear in the fax machine display and cordless handset display, beginning just before the second ring. The information will continue to be displayed until the line is disconnected.

Display example (fax machine display)

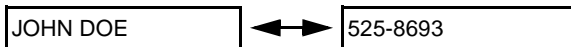

Caller's name

Caller's number

**Note:** Some caller ID services may not provide the name of the caller. In this case, only the phone number will appear.

### ***Display messages***

One of the following messages will appear while the fax rings if caller information is not available.

**NO SERVICE** No caller information was received from your telephone company. Make sure that the telephone company has activated your service.

**CALLER-ID ERROR** Noise on the telephone line prevented reception of caller information.

**OUT OF AREA** The call was made from an area which does not have a caller identification service, or the caller's service is not compatible with that of your local phone company.

**PRIVATE CALL** Caller information was not provided by the telephone company at the caller's request.

## Viewing the Caller ID list



If you subscribe to a Caller ID service and have turned on the Caller ID function, your fax machine will keep information on the most recent 30 calls and faxes you have received. You can view this information, which consists of the name and number of each caller, in the Caller ID List.

- ◆ After you have received 30 calls, each new call will delete the oldest call.
- ◆ All calls will be erased if you unplug the fax or a power failure occurs.

Follow the steps below to view the Caller ID List in the fax machine display. If desired, you can immediately dial a number when it appears.

**1** Press  twice.



**<REVIEW CALLS>** 

**2** Press  or  to scroll through the list.

**3** If you wish to dial one of the numbers in the list, scroll through the list until the number appears in the display.

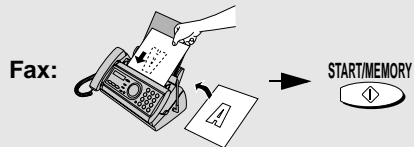
- **Fax:** If you wish to send a fax, load the document and then press . Dialing and transmission begin.





- **Voice call:** If you wish to make a voice call, pick up the handset (or press ). Dialing begins automatically. (If you pressed , pick up the handset when the other party answers.)



**4** Press  when you have finished viewing the list.

## To delete calls from the Caller ID list

If you want to delete a single call from the caller list, press  while the call appears in the display. If you want to delete all calls from the list, hold  down for at least 3 seconds while you are viewing any number in the list.

## Viewing the Caller ID list from the cordless handset

You can also view the Caller ID list in the cordless handset display, and automatically dial a number from the list. (Note that the cordless handset and the fax machine share the same list.)



**1** Press **REVIEW** .

Cordless handset display:

REVIEW CALLS  
▲▼: REVIEW

**2** Press  or  to scroll through the numbers in the list.

**3** While viewing the list, you can do the following:

- **Dial a number:** Scroll to the desired number and then press . (Note: You can only make a phone call from the cordless handset; you cannot start a fax transmission.)
- **Erase a call:** Scroll to the call you wish to erase, press , and then press .

**4** Press  when you have finished viewing the list.

## Erasing all calls using the cordless handset

Follow these steps to erase all calls from the Caller ID list using the cordless handset.

**1** Press **REVIEW** .

Cordless handset display:

REVIEW CALLS  
▲▼: REVIEW

**2** Press  **ERASE**.

ERASE ALL?  
PRESS START KEY



**3** Press .

- To cancel, press .



## Priority Call

If you have turned on Caller ID, you can set the machine to make a special ringing sound when you receive a call from a designated phone number. This lets you know immediately who is calling without having to look at the display.

To use this function, enter the desired phone number by following the steps below (only one phone number can be entered).

**1** Press **FUNCTION**  once and  **3 times**.

Display: **ENTRY MODE** 

**2** Press  once and  once.

**PRIORITY #** 

**3** Press  once.

**1=SET, 2=CLEAR**

**4** Press  to store a number.

(To clear a previously stored number, press  and go to Step 6.)

**5** Enter the number by pressing the number keys (max. 20 digits).

**6** Press  to store (or clear) the number.



**7** Press  to return to the date and time display.

## ***Blocking voice calls***

If you have turned on Caller ID, you can use the Anti Junk Fax function described in *Blocking Reception of Unwanted Faxes* in this chapter to block voice calls as well as faxes from your specified Anti Junk Number.

In this case, when a voice call or a fax transmission comes in from the number you have specified as a "Junk Number", your fax will break the connection as soon as it receives the calling phone number from the caller ID service (before the second ring).

To use this function, enter the number that you wish to block as explained in *Blocking Reception of Unwanted Faxes* (see page 102). Only one number can be blocked.

**Note:** This function cannot be used if you are using the Distinctive Ring function.

## Distinctive Ring (Requires Subscription to Service)

### Important:

- ◆ **To use distinctive ring, you must subscribe to a distinctive ring service from your local phone company.**
- ◆ Your fax machine may not be compatible with some distinctive ring services.

Distinctive ring is a service offered by some local telephone companies whereby they assign an additional second number to your regular single line. The second number rings differently from your normal number.

If you subscribe to a distinctive ring service, you can set the fax machine to automatically answer when your second number is called. This allows you to use the second number as an exclusive fax number. To have your fax automatically answer when your second number is called, follow the steps below:

**1** Press **FUNCTION** once and **▲** twice.

Display:

OPTION SETTING 

**2** Press **▶** once and **▼** 3 times.

DISTINCTIVE 

**3** Press **▶** once.

**4** Press a number from 1 to 3 to select the ring pattern below that matches your second number's ring pattern. Or, press 4 to have your fax automatically answer your normal telephone number. Press 5 to turn off the distinctive ring function.

- |          |                |   |
|----------|----------------|---|
| <b>1</b> | RING PATTERN 1 | Two short rings                         |
| <b>2</b> | RING PATTERN 2 | One short, one long, and one short ring |
| <b>3</b> | RING PATTERN 3 | Two short rings and one long ring       |
| <b>4</b> | STANDARD RING  | Your standard (normal) ring pattern     |
| <b>5</b> | OFF SETTING    | Turn distinctive ring off               |

## Blocking Reception of Unwanted Faxes

The display briefly shows your selection, then:

FAX SIGNAL RX 

**5** Press  to return to the date and time display.

**6** Set the reception mode to FAX.

RESOLUTION/  
RECEPTION MODE 

TEL FAX





TAD



- ◆ When using distinctive ring, you must set the reception mode of your fax machine to FAX. When your designated fax number is dialed, your fax will automatically answer and begin reception after two rings. Note that other devices on the same line will also ring until your fax answers. If one of your other numbers is dialed, the fax will ring; however, it will not answer.

## Blocking Reception of Unwanted Faxes

The Anti Junk Fax function allows you to block reception of faxes from a party that you specify. This saves paper by not printing out unwanted "junk" faxes. To use this function, follow the steps below to enter the fax number from which you do not wish to receive faxes. One fax number can be entered.

**1** Press  once and  3 times.



Display: ENTRY MODE 

**2** Press  once and  twice.

ANTI JUNK # 

**3** Press  once.

1=SET, 2=CLEAR

**4** Press  to store an Anti Junk number, or  to clear a previously stored number (if you are clearing a number, go to Step 6).

**5** Enter the fax number by pressing the number keys (max. 20 digits).

**6** Press  and then press  to return to the date and time display.



# 9. Printing Lists

You can print lists showing settings and information entered in the fax machine. The lists are described below. To print a list, follow these steps.

**1** Press **FUNCTION** once and **▼** twice.

Display:

LISTING MODE 

**2** Press **▶** once.

TEL # LIST 

**3** Press **▲** or **▼** until the desired list appears in the display.

**4** Press **▶** once.

PRESS START KEY

**5** Press **START/MEMORY**  to print the list.

## Telephone Number List

This list shows the fax and phone numbers that have been stored for automatic dialing.

## Setup List

This list shows your current selections for the **FUNCTION** key settings. The list also shows your name and fax/telephone number as entered in the machine, and a sample of the header printed at the top of every page you transmit (**HEADER PRINT**).

SETUP LIST		JAN-19-2002 03:34 PM
FOR: SHARP-SHOP		794 8675
***T.A.D. SETTING***		
TOLL SAVER		YES
RECORDING TIME		4 MIN.
REMOTE CODE #		001
OVERRIDE CODE #		009
TRANSFER TELEPHONE #		1539-47036
TRANSFER TELEPHONE CALLING		NO
ON T.A.D. FAILURE		NO
(UNIT SETS TO AUTO FAX RCV.)		
OGM ONLY MODE		NO
***ENTRY MODE***		
ANTI JUNK #		
PRIORITY CALL #		
SENDER'S NAME		SHARP-SHOP
SENDER'S TELEPHONE #		794 8675
HEADER PRINT		
JAN-19-2002 03:34 PM	SHARP-SHOP	794 8675 P.01
***OPTION SETTING***		
NUMBER OF RINGS IN AUTO ANSWER MODE		4 RINGS
TRANSACTION PRINT SELECT		ERROR ONLY
DIAL MODE		TO NE
DISTINCTIVE RINGING		OFF
FAX SIGNAL RECEIVE		YES
CALLER-ID		NO
ECH MODE		YES
DAY LIGHT SAVING TIME		NO
RECEPTION RATIO		AUTO
PRINT CONTRAST		NORMAL
PAPER SIZE SET		LETTER
COPY CUT OFF		YES
***LCR SETTING***		
LCR FUNCTION ON/OFF (#106#/#104#)		ON
LCR DIAL SELECT		YES
LCR TIME SELECT		02,04 MINUTES
LCR TABLE SELECT		TABLE NOT EXIST
CENTER #		19703772160

## Message List

This list shows information about the messages currently recorded in the answering machine, including the date and time each messages was recorded, the length, and the type.

## Caller-ID List

This list shows information about your 30 most recent calls. (This list is only available if you are using the Caller ID function.)

## Transaction Report

This report is printed out automatically after an operation is completed to allow you to check the result. Your fax machine is set at the factory to print out the report only when an error occurs.

- ◆ The Transaction report cannot be printed on demand.

### Headings in Transaction Report

**SENDER/  
RECEIVER** The name or fax number of the other machine involved in the transaction. If that machine does not have an ID function, the communication mode will appear (for example, "G3").

**START** The time at which transmission/reception started.

**TX/RX TIME** Total time taken for transmission/reception.

**PAGES** Number of pages transmitted/received.

**NOTE** (One of the following notes will appear under **NOTE** in the report to indicate whether the transaction was successful, and if not, the reason for the failure.)

**OK** - Transmission/reception was successful.

**P.FAIL** - A power failure prevented the transaction.

**JAM** - The printing paper or document jammed, preventing the transaction.

**BUSY** - The fax was not sent because the line was busy.

**COM.E-X** - (Where "X" is a number.) A telephone line error prevented the transaction. See *Line error* on page 112.

**CANCEL** - The transaction was cancelled because the **STOP** key was pressed, no document was in the feeder, or the other machine requested transmission using a function which your fax machine does not have. If you were attempting to fax, make sure a document is in the feeder. If you were receiving, contact the faxing party to see how they are trying to send to you.

## Transaction Report print condition

You can change the condition under which a Transaction Report is printed out. Follow the steps below.

**1** Press **FUNCTION** once and **▲** twice.

Display:

OPTION SETTING 

**2** Press **▶** once and **▼** once.

TRANSACTION 

**3** Press **▶** once.

1:ALWAYS PRINT

(Selections appear alternately)

**4** Press a number from **①** to **⑤** to select the condition for printing.

- |                       |  |
|-----------------------|--|
| <b>①</b> ALWAYS PRINT | A report will be printed after each transmission, reception, or error. |
| <b>②</b> ERROR/MEMORY | A report will be printed after an error or a memory operation.         |
| <b>③</b> SEND ONLY    | A report will be printed after each transmission.                      |
| <b>④</b> ERROR ONLY   | A report will be printed only when an error occurs.                    |
| <b>⑤</b> NEVER PRINT  | A report will never be printed.  |

The display briefly shows your selection, then:

DIAL MODE 

**5** Press **STOP** to return to the date and time display.

# 10. Maintenance

## Print head

Clean the print head frequently to ensure optimum printing performance.

**Note:** Remove the paper from the paper tray before cleaning the print head.

- 1 Unplug the power cord, and open the operation panel (press **1**).

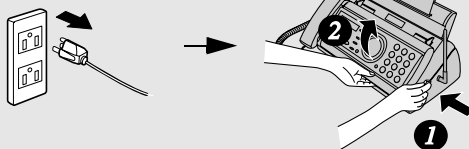

- 2 Take the imaging film out of the print compartment and place it on a sheet of paper.

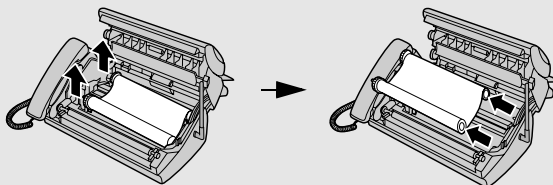

- 3 Wipe the print head with isopropyl alcohol or denatured alcohol.

### Caution!

- Do not use benzene or thinner. Avoid touching the print head with hard objects.
- The print head may be hot if your fax machine has just received a large number of documents. If this is the case, allow the print head to cool prior to cleaning.

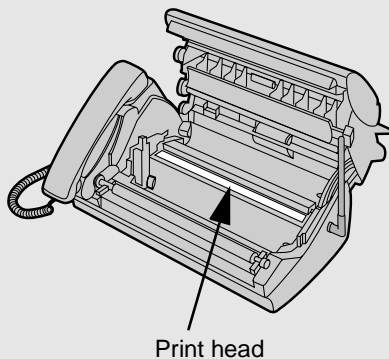

- 4** Place the imaging film back in the print compartment.

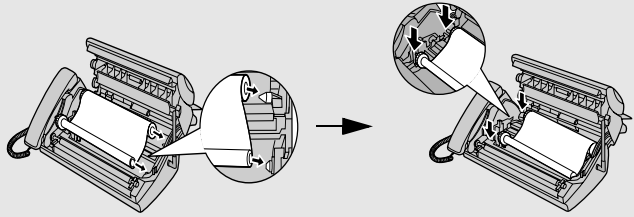

- 5** Rotate the front gear until the film is taut, and then close the operation panel (press down on both sides to make sure it clicks into place).

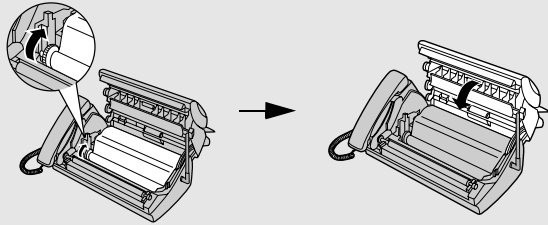

## Scanning glass and rollers

Clean the scanning glass and rollers frequently to ensure the quality of transmitted images and copies.

**Note:** Remove the paper from the paper tray before cleaning the scanning glass and rollers.

- 1** Open the operation panel (press **1**).

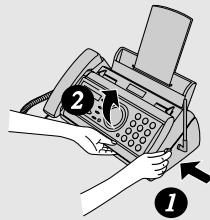

- 2** Flip up the green levers on each side of the white roller.

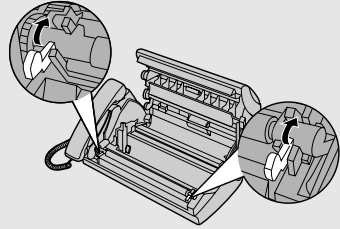

- 3** Wipe the scanning glass (under the white roller) and rollers with a cotton swab.

- Make sure that all dirt and stains (such as correcting fluid) are removed. Dirt and stains will cause vertical lines on transmitted images and copies.

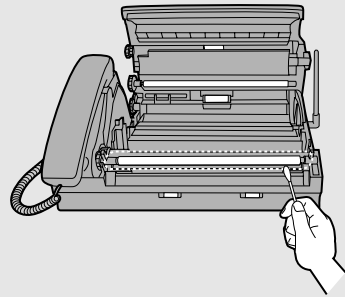

**If the scanning glass is difficult to clean**

If you find it difficult to remove dirt from the scanning glass, you can try moistening the swab with isopropyl alcohol or denatured alcohol. Take care that no alcohol gets on the rollers.

- 4** Flip down the green levers on each side of the white roller. Rotate the front gear until the film is taut, and then close the operation panel (press down on both sides to make sure it clicks into place).

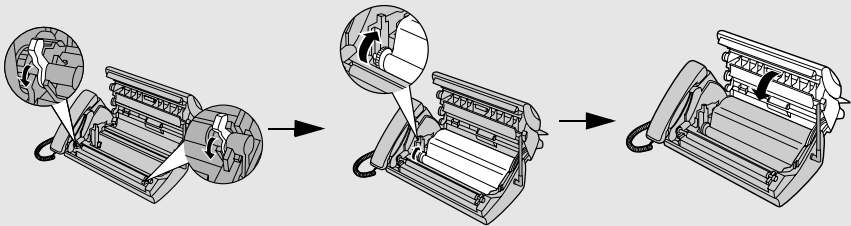

## The housing

Wipe the external parts and surface of the machine with a dry cloth.

**Caution!**

Do not use benzene or thinner. These solvents may damage or discolor the machine.

## Replacing the Cordless Handset Battery

Like any other battery, the rechargeable battery will eventually wear out. The battery can normally be used for about two years, although this will vary depending on the conditions of use.

If LOW BATTERY continues to appear in the cordless handset display after the battery has been charged for 10 hours, replace it with the following battery:

**Replacement battery:** Use only a **Sharp UX-BA01** battery (3.6 V Ni-MH battery, capacity: 850 mAh)

**Caution:**

Danger of explosion if battery is incorrectly replaced. Replace only with the same or equivalent type recommended by the manufacturer. Dispose of used batteries according to the manufacturer's instructions.

- 1 Remove the battery cover by pressing on the indentation as shown.**

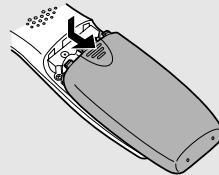

- 2 Unplug the battery connector and remove the old battery.**

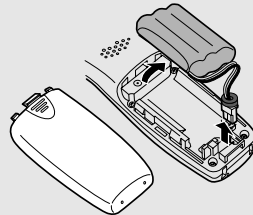

- 3 Connect the battery connector ❶ of the new battery, and then place the battery in the cordless handset, placing the wires as shown.**

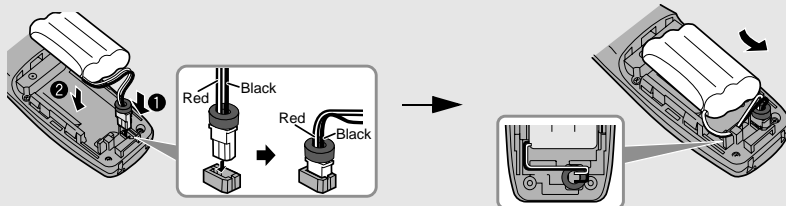



- 4** Place the battery cover on the cordless handset, making sure it snaps firmly into place.

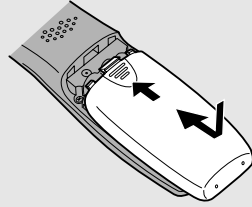

- 5** Place the cordless handset in the charger with the dial pad facing forward.

- Let the new battery charge for at least **10** hours.

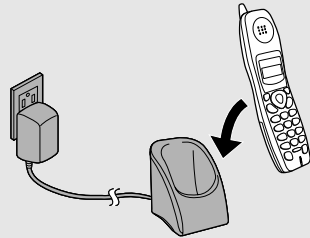

## ***Battery disposal***

The battery pack contains a Nickel Metal Hydride battery. The battery must be disposed of properly. Contact local agencies for information on recycling and disposal plans in your area.

## ***Wiping the charger contacts***

To ensure that the battery charges properly, wipe the charger contacts once a month with a cotton swab.

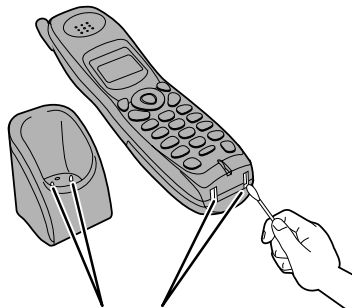

Charger contacts

---

# 11. Troubleshooting

## Problems and Solutions

If you have any problems with your fax, first refer to the following troubleshooting guide. If you cannot solve the problem, call Sharp's Customer Assistance Center at 1-877-794-8675.

### Line error

Problem	Solution
LINE ERROR appears in the display.	<p>Try the transaction again. If the error persists, check the following:</p> <ul style="list-style-type: none"><li>• Check the connection. The cord from the <b>TEL. LINE</b> jack to the wall jack should be no longer than six feet.</li><li>• Make sure there are no modem devices sharing the same telephone line.</li><li>• Check with the other party to make sure their fax machine is functioning properly.</li><li>• Have your telephone line checked for line noise.</li><li>• Try connecting the fax machine to a different telephone line.</li><li>• If the problem still occurs, your fax machine may need service.</li></ul>

***Dialing and transmission problems***

<b>Problem</b>	<b>Solution</b>
No dial tone when you pick up the handset or press the <b>SPEAKER</b> key.	<ul style="list-style-type: none"> <li>• Make sure the handset cord is connected to the correct jack. See <i>Connecting the handset</i> on page 14.</li> </ul>
Dialing is not possible.	<ul style="list-style-type: none"> <li>• Make sure the power cord is properly plugged into a power outlet.</li> <li>• Make sure that the telephone line is properly connected to both the <b>TEL. LINE</b> jack and the wall jack (see page 15).</li> <li>• Make sure that the fax machine is set to the correct dialing mode for your telephone line. See <i>Dial mode</i> on page 15.</li> </ul>
The power is on, but no transmission takes place.	<ul style="list-style-type: none"> <li>• Make sure that the receiving machine has paper.</li> <li>• If the receiving machine is in manual mode with no attendant, reception will not be possible.</li> <li>• Check the display for error messages.</li> <li>• Pick up the handset and check for a dial tone.</li> </ul>
Nothing is printed at the receiving end.	<ul style="list-style-type: none"> <li>• Make sure that the document for transmission is placed face down in the feeder.</li> </ul>
A distorted image is received at the other end.	<ul style="list-style-type: none"> <li>• Noise on the telephone line may cause distortion. Try sending the document again.</li> <li>• Make a copy of the document on your fax machine. If the copy is also distorted, your fax machine may need service.</li> </ul>

## ***Reception and copying problems***

<b>Problem</b>	<b>Solution</b>
<p>The fax machine doesn't receive documents automatically.</p>	<ul style="list-style-type: none"> <li>• Make sure that the reception mode is set to FAX. If you subscribe to a distinctive ring service, make sure that the Distinctive Ring function is set to the correct ring pattern. If you do not subscribe to a distinctive ring service, make sure that Distinctive Ring is set to OFF SETTING. (See <i>Distinctive Ring</i> on page 101.)</li> </ul>
<p>The printing paper comes out blank when you try to receive a document.</p>	<ul style="list-style-type: none"> <li>• Make sure that the document is loaded properly in the feeder of the transmitting machine. Make a copy or print a report to confirm the printing ability of your machine.</li> </ul>
<p>General print quality is poor.</p>	<ul style="list-style-type: none"> <li>• It is important to select a paper that is appropriate for the thermal transfer printer in your fax. We recommend using laser quality paper that has a very smooth finish. Copier paper will work, but it sometimes tends to yield a lighter print quality.</li> </ul>
<p>The received document is faint.</p>	<ul style="list-style-type: none"> <li>• Ask the other party to send higher contrast documents. If the contrast is still too low, your fax machine may need service. Make a copy or print a report to check your machine's printing ability.</li> </ul>
<p>Received images are distorted.</p>	<ul style="list-style-type: none"> <li>• Noise on the telephone line may cause distortion. Have the other party try sending the document again.</li> <li>• The print head may be dirty. See <i>Print head</i> on page 107.</li> <li>• Make a copy or print a report on your fax machine. If the copy or report is also distorted, your fax machine may need service.</li> </ul>
<p>A received document or copy prints out in strips.</p>	<ul style="list-style-type: none"> <li>• Make sure the operation panel is completely closed (press down on both sides of the panel).</li> </ul>

The quality of copies is poor and/or dark vertical lines appear.	<ul style="list-style-type: none"> <li>Any dirt or material on the scanning glass will cause spots to appear on copies and transmitted faxes. Clean the scanning glass as explained on page 108.</li> </ul>
Reception/copying is interrupted.	<ul style="list-style-type: none"> <li>If reception or copying takes place continuously for a long time, the print head may overheat. Turn off the power and let it cool down. If overheating frequently occurs, try changing the print contrast setting to LIGHT (see page 24).</li> </ul>
Dark vertical lines appear on copies and received faxes.	<ul style="list-style-type: none"> <li>Try changing the print contrast setting to LIGHT (see page 24).</li> </ul>

### General problems

Problem	Solution
Auto-dial numbers cannot be stored in the fax.	<ul style="list-style-type: none"> <li>Make sure the fax is plugged in and the imaging film has been loaded. (Auto-dial numbers cannot be stored if the imaging film has not been loaded.) See <i>Loading the Imaging Film</i> in Chapter 1.</li> </ul>
Nothing appears in the display.	<ul style="list-style-type: none"> <li>Make sure the power cord is properly plugged into a power outlet.</li> <li>Connect another electrical appliance to the outlet to see if it has power.</li> </ul>
The machine does not respond when you press any of its keys.	<ul style="list-style-type: none"> <li>If a beep sound is not made when you press the keys, unplug the power cord and then plug it in again several seconds later.</li> </ul>
Automatic document feeding does not work for transmission or copying.	<ul style="list-style-type: none"> <li>Check the size and weight of the document (see <i>Transmittable Documents</i> on page 73).</li> </ul>

### ***Cordless handset problems***

<b>Problem</b>	<b>Solution</b>
The cordless handset does not operate and nothing appears in the display.	<ul style="list-style-type: none"><li>• Make sure the battery is properly connected inside the cordless handset (see page 18).</li><li>• The battery may be low. Place the cordless handset in the charger and let it charge.</li></ul>
Calls cannot be made or received on the cordless handset.	<ul style="list-style-type: none"><li>• Make sure the fax machine is plugged into a power outlet and has power.</li><li>• Make sure the telephone line is properly connected to both the <b>TEL. LINE</b> jack on the fax machine and the wall jack (see page 15). (If the telephone line is connected correctly, you should hear a dial tone when you pick up the fax machine handset.)</li><li>• The battery may be low. Place the cordless handset in the charger and let it charge.</li><li>• Calls cannot be made or received while the fax machine is being used (while FAX BUSY appears in the cordless handset display). Wait until the fax machine is no longer being used.</li><li>• Calls cannot be made or received during a power failure.</li><li>• You may be outside of the talking range. Move closer to the fax machine.</li></ul>

<p>The battery does not charge.</p>	<ul style="list-style-type: none"> <li>• Make sure the cordless handset is placed in the charger with the dial pad facing forward.</li> <li>• Make sure the AC adapter is connected correctly to the charger and the power outlet (see page 17).</li> <li>• Wipe the charger contacts with a cotton <u>swab</u>.</li> <li>• Make sure the battery is properly connected inside the cordless handset (see page 18).</li> <li>• The battery may need replacement (see page 110).</li> </ul>
<p>You hear noise or interference during a call.</p>	<ul style="list-style-type: none"> <li>• Make sure the base antenna is fully upright on the fax machine (see page 17).</li> <li>• Other electrical appliances may cause interference. Move away from any electrical appliances.</li> <li>• Move closer to the fax machine. Note that large metal objects, metal structures, and thick walls between the fax machine and cordless handset will reduce the talking range. If needed, try moving the fax machine to a different location.</li> </ul>
<p>You hear beeps during a call.</p>	<ul style="list-style-type: none"> <li>• You will hear beeps during a call and <b>LOW BATTERY</b> will appear in the display if the battery is low. Place the cordless handset in the charger and let it recharge. If you hear beeps during a call and need to continue the call, press the <b>INTERCOM</b> key to transfer the call to the fax machine.</li> <li>• You will hear beeps during a call and <b>OUT OF RANGE</b> will appear in the display if you are outside of the talking range. Move closer to the fax machine.</li> </ul>

## Messages and Signals

### Display messages (fax machine)

**Note:** If you have turned on the Caller ID function, see page 96 for display messages related to Caller ID.

ADD PAPER & / PRESS START KEY (alternating messages)	Check the printing paper. If the tray is empty, add paper and then press the <b>START/MEMORY</b> key. If there is paper in the tray, make sure it is inserted correctly (take out the stack, align the edges evenly, and then reinsert it in the tray) and then press the <b>START/MEMORY</b> key.
CHECK FILM/ CHECK COVER/ CHECK PAPER JAM (alternating messages)	These alternating messages appear when there is a problem in the print compartment that prevents printing. Check to see if the imaging film is not loaded properly or if it has been used up and needs replacement. Make sure the operation panel is completely closed (press down on both sides). If a paper jam has occurred, clear the jam as explained in the following section, <i>Clearing Paper Jams</i> .
CHECK PAPER SIZE	The paper size setting is incorrect. Change the paper size setting as explained on page 24.
CORDLESS IN USE	The cordless handset is being used. Wait until this message no longer appears to send a fax or make a phone call.
DOCUMENT JAMMED	The original document is jammed. See the following section, <i>Clearing Paper Jams</i> . Document jams will occur if you load more than 10 pages at once or load documents that are too thick (see page 73). The document may also jam if the receiving machine doesn't respond properly when you attempt to send a fax.
DOWNLOAD ERROR	The fax machine was unable to download rate data from OpenLCR. Try downloading the data manually as explained in <i>Downloading (receiving) the rate data manually</i> on page 36.



FAX RX IN MEMORY	A fax has been received in memory because the imaging film needs replacement, you have run out of printing paper, or the paper is jammed. The fax will print out automatically when the problem is fixed.
FUNCTION MODE	The <b>FUNCTION</b> key has been pressed.
INTERCOM	The <b>INTERCOM</b> key has been pressed to page the cordless handset, or the cordless handset is paging the fax machine. Lift the handset to talk. When you are finished talking, replace the handset.
LCR DOWNLOADING	The fax machine has called OpenLCR and is receiving carrier rate data. This message only appears if you have registered with OpenLCR.
LINE ERROR	Transmission or reception was not successful. Press the <b>STOP</b> key to clear the message and then try again. If the error persists, see <i>Line Error</i> on page 112.
LOW BATTERY	This will appear if you have pressed the <b>INTERCOM</b> key to page the cordless handset and the cordless handset battery is too low for the cordless handset to respond.
MEMORY IS FULL/ SEE MANUAL (alternating messages)	The memory is full. You may have too many messages recorded in the answering system. To erase messages, see page 47. This message may also occur during fax reception if too much data is received before the pages can be printed out. If faxes have been received to memory because printing is not possible (an additional message will indicate the problem), resolve the problem so that printing can continue (see <i>Substitute Reception to Memory</i> on page 92). If you are attempting to transmit from memory, see <i>If the memory becomes full</i> on page 86. If you are copying, see <i>If MEMORY IS FULL appears</i> on page 93.
MEMORY PRINTING	The fax is preparing to or printing out a document from memory.

## Messages and Signals

NO DATA	This appears if you attempt to search for an auto-dial number when none have been stored.
NO SERVICE	This appears if you haven't registered with OpenLCR and press the <b>FUNCTION</b> key and <b>7</b> .
OFF HOOK	This appears if you forgot to replace the handset after using it to dial and send a fax. Replace the handset or press the <b>STOP</b> key to clear the message.
ON HOOK DIAL	The <b>SPEAKER</b> key has been pressed and the fax machine is waiting for you to dial.
OUT OF RANGE	This will appear if you have pressed the <b>INTERCOM</b> key to page the cordless handset and it is outside of the talking range.
OVER HEAT	The print head has overheated. Operation can be continued after it cools. If overheating frequently occurs, try changing the print contrast setting to <b>LIGHT</b> (see page 24).
PRINT HEAD FAIL/ YOU NEED SERVICE (alternating messages)	The print head has failed and requires service.
READY TO SEND	A document has been loaded and the fax machine is waiting for you to begin faxing or copying.
RECALLING	This appears if you attempt to send a fax by automatic dialing and the line is busy or the receiving fax machine does not answer. Your fax machine will automatically reattempt the call. (See <i>Automatic redialing</i> on page 83.)
REPLACE HANDSET	This appears if an outside call comes in while you are paging or talking to the cordless handset using the Intercom feature. Replace the fax machine handset to stop the Intercom call, and then pick it up again to answer the outside call.
T.A.D. TRANSFER	The answering system's transfer function has been turned on (see page 50).

TOTAL MSGS:XX	This indicates that you have received messages in the answering system. "XX" is the number of messages.
TOTAL PAGE(S) 01	Number of pages transmitted, received, or copied.

### ***Display messages (cordless handset)***

CHARGING	The cordless handset is in the charger and the battery is charging.
FAX BUSY	The fax machine is in use. Wait until the fax machine is no longer being used to use the cordless handset.
HOLD	A call has been placed on hold by pressing the <b>HOLD</b> key. To resume the call, press the <b>HOLD</b> key again.
IN CHARGER	The cordless handset is in the charger and is fully charged (the cordless handset can be left in the charger without damaging the battery).
INTERCOM	The <b>INTERCOM</b> key has been pressed to page the fax machine, or the fax machine is paging the cordless handset. Press the <b>TALK</b> key to talk. When you are finished, press the <b>OFF</b> key.
LOW BATTERY	The cordless handset battery is low. Place the cordless handset in the charger and let it recharge. If this message continues to appear after recharging, the battery may need replacement (see page 110). If this message appears during a phone call (you will also hear beeps) and you wish to continue the call, press the <b>INTERCOM</b> key to transfer the call to the fax machine.
NEW MESSAGES	New messages have been received in the answering system. You can either listen to the messages using the cordless handset (see page 71), or using the fax machine (see page 46).

OUT OF RANGE	The cordless handset is outside of the talking range of the fax machine. When talking on the cordless handset, the handset will beep and you may hear interference. Move closer to the fax machine.
REMOTE MODE	The <b>REMOTE/FLASH</b> key has been pressed. For information on using REMOTE MODE, see page 71.
STAND-BY	This appears when the cordless handset is not in the charger and is ready to be used.
TALK	The <b>TALK</b> key has been pressed to make a phone call.

### ***Audible signals***

Continuous tone	3 seconds	Indicates the end of transmission, reception, or copying.
Intermittent tone (3 beeps)	5 seconds (1 second on, 1 second off)	Indicates incomplete transmission, reception, or copying.
Rapid intermittent tone	35 seconds (0.7 seconds on, 0.3 seconds off)	Indicates that the handset is off hook.

# Clearing Paper Jams

## Clearing a jammed document

If the original document doesn't feed properly during transmission or copying, or DOCUMENT JAMMED appears in the display, first try pressing **START/MEMORY** . If the document doesn't feed out, remove it as explained below.

### Important:

Do not try to remove a jammed document without releasing it as explained below. This may damage the feeder mechanism.

- 1 Press **1** and slowly open the operation panel until it is half open.

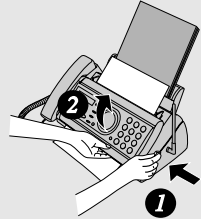

- 2 Flip up the green levers on each side of the white roller.

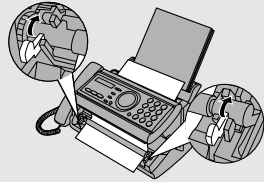

- 3 Gently remove the document.

- Be careful not to tear the document.

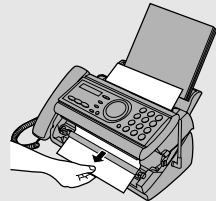

- 4** Flip down the green levers on each side of the white roller. Rotate the front gear until the film is taut, and then close the operation panel (press down on both sides to make sure it clicks into place).

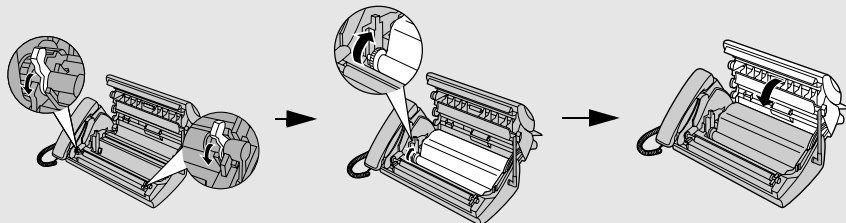

### Clearing jammed printing paper

- 1** Open the operation panel (press **1**).



- 2** Gently pull the jammed paper out of the machine, making sure no torn pieces of paper remain in the print compartment or rollers.

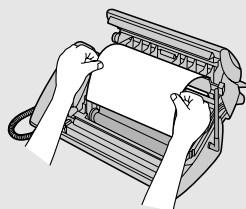

- 3** Rotate the front gear until the film is taut, and then close the operation panel (press down on both sides to make sure it clicks into place).

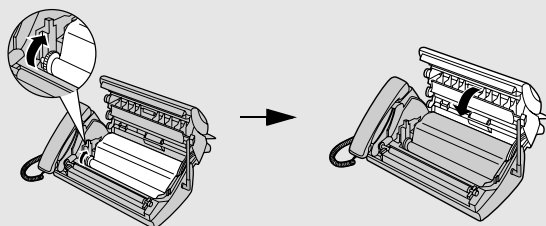

## Ordering Parts

To order parts, contact the parts distribution center located nearest you. When ordering a part, use the part order number shown below.

Operation manual	TINSE4267XHTZ
Setup Guide	TCADZ3323XHZZ
Handset cord	QCNWG209BXHBW
Telephone line cord	QCNWG208BXHZZ
Handset	DUNTK468BXHBW
Paper tray	CPLTP3183XHR7
Paper tray extension	LPLTP3184XHZZ
Gears	CGERH2566XH01 NGERH2568XHZZ
AC adapter	RADPA2027XHZZ
Cordless handset charger	RUNTZ2100XHE1

### Part distribution centers

Tritronics, Inc. 1306 Continental Drive Abingdon, MD 21009	Tel: 1-800-638-3328 Fax: 1-800-888-FAXD
--	--

Tritronics, Inc. 1015 NW 52nd Street Ft. Lauderdale, FL 33309	Tel: 1-800-365-8030 Fax: 1-800-999-FAXD
---	--

Fox International, Ltd. 23600 Aurora Road Bedford Heights, OH 44146	Tel: 1-800-321-6993 Fax: 1-800-445-7991
---	--

Andrews Electronics 25158 Avenue Stanford Santa Clarita, CA 91355	Tel: 1-800-274-4666 Fax: 1-805-295-5126
---	--

Sharp Accessories and Supply Center 2130 Townline Road Peoria, IL 61615	Tel: 1-800-642-2122
--	---------------------

## ***FCC Regulatory Information***

This equipment complies with FCC rules, Part 68. On this equipment is a label that contains, among other information, the Registration Number and Ringer Equivalence Number (REN) for this equipment. If requested, this information must be provided to your telephone company.

An FCC compliant telephone cord and modular plug is provided with this equipment. This equipment is designed to be connected to the telephone network or premises wiring using a compatible modular jack which is Part 68 compliant. This equipment connects to the telephone network through a standard USOC RJ-11C network interface jack.

The REN is used to determine the quantity of devices which may be connected to your telephone line and still have all of those devices ring when your number is called. Too many devices on one line may result in the devices not ringing in response to an incoming call. In most, but not all, areas as the sum of the RENs of all devices should not exceed five (5.0). To be certain of the number of devices that may be connected to your line, as determined by the total REN, contact your local telephone company.

If this equipment causes harm to the telephone network, your telephone company may disconnect your service temporarily. If possible, they will notify you in advance. If advance notice is not practical, you will be notified as soon as possible. You will also be advised of your right to file a complaint with the FCC.

Your telephone company may make changes in its facilities, equipment, operations, or procedures that could affect the operation of your equipment. If this happens, the telephone company will provide advance notice in order for you to make necessary modifications to maintain uninterrupted service. If the equipment is causing harm to the telephone network, your telephone company may ask you to disconnect the equipment until the problem resolved.

If you have any questions or problems which cannot be solved by reading this manual, please contact Sharp's Customer Assistance Center. The number is 1-877-794-8675.

This equipment may not be used on coin service provided by the telephone company. Connection to party lines is subject to state tariffs. Contact your state's public utility commission, public service commission, or corporation commission for more information.

This equipment is hearing-aid compatible.

When programming and/or making test calls to emergency numbers:

- ◆ Remain on the line and briefly explain to the dispatcher the reason for the call.
- ◆ Perform such activities in the off-peak hours, such as early morning or late evening.



# S H A R P

Date Revised: \_\_\_\_\_

Date Issued : July. 3. 2001

## MATERIAL SAFETY DATA SHEET (1/2)

MSDS No. B-1026

### Section 1. Product and Company Identification

**Product Name :** IMAGING FILM UX-5CR**Supplier Identification :** Sharp Corporation  
22-22 Nagaike-cho, Abeno-ku, Osaka, Japan**Manufacturer :** DAINIPPON PRINTING CO. LTD.  
591-2, Kamihirose, Higashikubo, Sayamashi, Saitama, 350-1321 JAPAN**Emergency telephone number :** +81-42-952-9666

Local suppliers are listed below. Please contact the nearest supplier for additional information.

(Country)	(Name and Telephone Number)
U.S.A.	Sharp Electronics Corporation Telephone number for information: 1-800-237-4277
Canada	Sharp Electronics of Canada Ltd. Telephone number for information : 905-890-2100 Emergency telephone number : 1-800-255-3924

### Section 2. Ingredients

Ingredients	CAS No.	Proportion	OSHA PEL	ACGIH TLV	Other
Polyethylene terephthalate film	25038-59-9	47 ~ 52%	-	-	None
<b>Coating layer substances</b>					
Carbon Black	1333-86-4	7 ~ 10%	3.5 mg/m <sup>3</sup>	3.5 mg/m <sup>3</sup>	None
Ester wax	8015-86-9	2 ~ 7%	-	-	None
Paraffin Wax	8002-74-2	10 ~ 14%	-	2.0 mg/m <sup>3</sup>	None
Microcrystalline wax	63231-60-7	16 ~ 22%	-	-	None
Ethylene Vinyl Acetate Copolymer	24937-78-8	1 ~ 5%	-	-	None
Others		1 ~ 6%	-	-	None

### Section 3. Hazardous Identification

<b>Route(s) of Entry:</b>	Inhalation?	Skin?	Ingestion?
	NO	NO	Possible but very unusual

**Signs and Symptoms of Exposure:** None**Medical Conditions Aggravated by Exposure:** None**POTENTIAL HEALTH EFFECTS:****Inhalation:** None**Skin Contact:** None**Eye Contact:** None**Ingestion:** None

### Section 4. First-Aid Measures

Inhalation: No applicable

Skin Contact: In case of contact, usually special care is not necessary. If it dirties skin, clear with water and soap.

Eye Contact: In case of contact, immediately flush eyes with plenty of water. If necessary, then care for medical attention.

Ingestion: Immediately make vomit it and rinse mouth with water. If necessary, then care for medical attention.

### Section 5. Fire-Fighting Measures

**Flash Point:** about 250 °C for ink**Autoignition:** None**Flammability Limits:** Not applicable**Extinguishing Media:** CO<sub>2</sub>, Water, Dry chemicals, Foam**Firefighting:** None**Fire and Explosion Hazard:** None**Hazardous Combustion Products:** None

# S H A R P

Date Revised: \_\_\_\_\_

Date Issued :July 3, 2001

## MATERIAL SAFETY DATA SHEET (2/2)

MSDS No. B-1026

### Section 6. Accidental Release Measures

Rumpling the product may cause the wax layer to peel off. Sweep up or vacuum. When sweeping, avoid raising film or dust. If a vacuum is used , motor should be rated as dust tight. Wash any residue off skin with soap and water. Garments may be wasted or dry cleaned after removal of loose film or dust.

### Section 7. Handling and Storage

No special precautions for safety reason.  
Store in cool, dry place ,avoid direct sunlight.

### Section 8. Exposure Control/Personal Protection

**Ventilation:** None  
**Eye Protection:** None  
**Protective Clothing:** None  
**Gloves:** None

### Section 9. Physical and Chemical Properties

**Description:** Not applicable  
**Melting Point:** 71 C  
**Pressurized:** None  
**pH:** None  
**Evaporation Rate:** Negligible  
**Volatility:** None  
**Freezing Point:** None  
**Boiling Point:** None  
**Specific Gravity (H20 = 1):** about 1.2  
**Water Solubility:** Not applicable

### Section 10. Stability and Reactivity

**Stability:** Stable  
**Conditions to Avoid:** None  
**Incompatibility(Materials to Avoid):** None  
**Hazardous Decomposition or Byproducts:** CO, CO2, NOX and H2O  
**Hazardous Polymerization:** Will not occur

### Section 11. Toxicological Information

**Acute Toxicity:** None  
**Chronic Toxicity:** None

### Section 12. Ecological Information

No environmental effect at normal use.

### Section 13. Disposal Consideration

Dispose by the same method of ordinary plastic products in accordance with all applicable regulations. Any disposal practice must be in compliance with local, state and federal laws and regulations. If necessary, contact government office and ensure conformity with disposal regulations.

### Section 14. Transport Information

No specific precautionary transport measure for safety reasons.  
As to storage conditions, see section 7.

### Section 15. Regulatory Information

None

### Section 16. Other Information

The information herein is given in good faith, but no warranty, if used any process.  
Final determination of suitability of any material is the sole responsibility of the user.  
Although certain information are described herein, we cannot guarantee, that these are the only hazard, which exist. Information on this data sheet represents our current data and best opinion as to the proper use in handling of this product under normal conditions.  
Restrictions: This information relates only to the specific material designated as supplied by the manufacturer. This information is supplied to us by the manufacturer and Sharp offers no warranties as to its accuracy and accepts no responsibilities for any typographical errors which may appear on these sheets. It is the responsibility of the user to determine the suitability of this product for each particular use.

# Quick Reference Guide

## Sending Faxes

Place your document (up to 10 pages) face down in the document feeder.

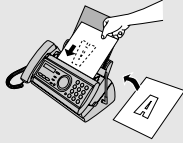

### Normal Dialing

1. Lift the handset or press **SPEAKER** .
2. Dial the fax number.
3. Wait for the reception tone (if a person answers, ask them to press their Start key).

4. Press **START/MEMORY** .

### Automatic Dialing

1. Press **▶** or **◀** until the desired destination appears in the display.
2. Press **START/MEMORY** .

### Direct Keypad Dialing

1. Dial the fax number.
2. Press **START/MEMORY** .

## Recording an Outgoing Message

1. Press **REC/MEMO** , **▼** , and **▶** .
2. Lift the handset, press **START/MEMORY** , and speak into the handset.
3. When finished, press **STOP** .

## Receiving Faxes

Press **RESOLUTION/RECEPTION MODE** until the arrow in the display points to the desired reception mode.

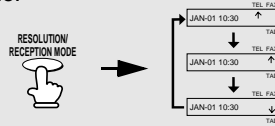

**FAX mode:** The fax machine automatically answers and receives faxes.

**TEL mode:** Answer all calls (even faxes) by picking up the handset. To begin fax reception, press **START/MEMORY** .

**TAD mode:** Select this mode when you go out to receive both voice messages and faxes.

## Storing Auto Dial Numbers

1. Press **FUNCTION** once and **▶** twice.
2. Enter the full fax/phone number.
3. Press **START/MEMORY** .
4. Enter a name by pressing number keys. (To enter two letters in succession that require the same key, press **▶** after entering the first letter.)

SPACE = 1	G = 4	N = 6 6	U = 8 8
A = 2	H = 4 4	O = 6 6 6	V = 8 8 8
B = 2 2	I = 4 4 4	P = 7	W = 9
C = 2 2 2	J = 5	Q = 7 7	X = 9 9
D = 3	K = 5 5	R = 7 7 7	Y = 9 9 9
E = 3 3	L = 5 5 5	S = 7 7 7	Z = 9 9 9
F = 3 3 3	M = 6	T = 8	

5. Press **START/MEMORY** and then **STOP** .

## Using the Cordless Phone

### Making a phone call

1. Pick up the cordless handset and press



2. When you hear the dial tone, dial the number.

3. When you are ready to end the call,

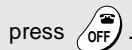

### Making a phone call using automatic dialing

1. Press SEARCH once.

2. Press or until the number you wish to dial appears in the display.

3. Press .

### Receiving a phone call

1. When the cordless handset rings, pick it up and press any key to answer.

2. When you are ready to end the call,



### Receiving a fax using the cordless handset

If you hear a fax tone after answering a call on the cordless handset, or if the other party speaks to you and then

wants to send a fax, press .

## Storing auto dial numbers

1. Press SEARCH and then .

2. Enter the full fax/phone number.

To clear a mistake, press .

To insert a pause, press .

3. Press .

4. Enter a name by pressing number keys. (To enter two letters in succession that require the same key, press after entering the first letter.)

SPACE = 1	G = 4	N = 6	U = 8
A = 2	H = 4	O = 6	V = 8
B = 2	I = 4	P = 7	W = 9
C = 2	J = 5	Q = 7	X = 9
D = 3	K = 5	R = 7	Y = 9
E = 3	L = 5	S = 7	Z = 9
F = 3	M = 6	T = 8	

5. Press and then .

### Listening to messages received in the answering system

1. Press .

2. Press to listen to all your

messages, or to listen to only your new messages.

3. While listening, you can press



4. When finished, press .

# Guía de referencia rápida

## Transmisión de mensajes telefax

Coloque el original (hasta 10 páginas) cara abajo en el alimentador de documentos.

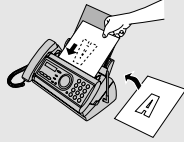

### Marcación normal

1. Levante el auricular u oprima: .
2. Marque el número de telefax.
3. Espere hasta escuchar el tono de recepción (si contestara una persona, pídale oprimir su tecla Start).
4. Oprima: .

### Marcación automática

1. Oprima la tecla de flecha o hasta que en el visor aparezca el destino deseado.

2. Oprima: .

### Marcación directa por teclado

1. Marque el número de fax.
2. Oprima: .

## Grabación de un mensaje de bienvenida

1. Oprima la tecla , tecla de flecha , y .
2. Levante el auricular, oprima la tecla y hable en el microteléfono.
3. Oprima la tecla cuando haya finalizado.

## Recepción de mensajes telefax

Oprima hasta que la flecha que hay en el display señale hacia el número de recepción deseado



**Modo FAX:** El aparato telefax contesta y transmite automáticamente mensajes telefax.

**Modo TEL:** Responda a todas las llamadas (incluso mensajes de fax), levantando el auricular. Para iniciar la recepción de fax,

oprima .

**Modo TAD:** Seleccione este modo cuando salga para recibir tanto mensajes hablados como telefax.

## Memorizar números marc. automática



1. Oprima una vez y dos veces.
2. Introduzca el número de telefax/teléfono completo.
3. Oprima: .
4. Ingrese el nombre oprimiendo las teclas numéricas. (Para ingresar sucesivamente dos letras que requieren la misma tecla, oprima después de ingresar la primera letra).

SPACE = 1	G = 4	N = 6 8	U = 8 8
A = 2	H = 4 4	O = 6 6 6	V = 8 8 8
B = 2 2	I = 4 4 4	P = 7	W = 9
C = 2 2 2	J = 5	Q = 7 7	X = 9 9
D = 3	K = 5 5	R = 7 7 7	Y = 9 9 9
E = 3 3	L = 5 5 5	S = 7 7 7 7	Z = 9 9 9 9
F = 3 3 3	M = 6	T = 8	





5. Oprima y luego .

## Uso del teléfono inalámbrico

### Hacer una llamada

1. Descuelgue el teléfono inalámbrico y oprima  .
2. Marque los números cuando escuche el tono de línea.
3. Oprima  cuando esté listo para finalizar la llamada.

### Hacer una llamada usando la función de marcación automática

1. Oprima una vez  .
2. Oprima  o  hasta que en el display aparezca el número que desea llamar.
3. Oprima  .

### Recibir una llamada

1. Cuando suene el timbre del teléfono inalámbrico, descuélguelo y oprima una tecla cualquiera para contestar.
2. Oprima  cuando esté listo para finalizar la llamada.

### Recibir un mensaje telefax usando el teléfono inalámbrico

Si después de atender una llamada con el teléfono inalámbrico escucha el tono de telefax o si el interlocutor desea remitirle un mensaje telefax, oprima  .

## Memorizar números para marcación automática

1. Oprima  y, a continuación,

FUNCTION  
/PAUSE  

2. Introduzca el número de teléfono/telefax completo.



Para borrar un error, oprima  .

Para introducir una pausa, oprima  .

3. Oprima  .



4. Introduzca un nombre mediante pulsación de las teclas numéricas. (Para introducir dos letras consecutivas que requieran el mismo código, oprima  después de introducir la primera letra.

SPACE = 1	G = 4	N = 6	U = 8
A = 2	H = 4	O = 6	V = 8
B = 2	I = 4	P = 7	W = 9
C = 2	J = 5	Q = 7	X = 9
D = 3	K = 5	R = 7	Y = 9
E = 3	L = 5	S = 7	Z = 9
F = 3	M = 6	T = 8	

5. Oprima  y, a continuación,  .

### Escuchar mensajes recibidos en el sistema de contestador automático

1. Oprima  .

2. Oprima  para escuchar todos sus mensajes o  para escuchar sólo los mensajes nuevos.

3. Mientras hace la escucha puede pulsar

 ,  ,  , o  .

4. Pulse  cuando haya terminado.

---

# Index

## A

- Answering system, activating, 44
- Anti Junk Fax, 102
- Audible signals, 122
- Auto-dial numbers
  - Storing, 63, 78
  - Using, 65, 81

## B

- Battery
  - Disposing of, 111
  - Installing, 18
  - Replacing, 110

## C

- Caller ID, 95-100
- Caller ID List, 104
- Contrast, 76
- Copies, 93
- Copy cut-off setting, 94
- Cordless handset
  - Auto-dial numbers, storing, 63
  - Auto-dial numbers, using, 65
  - Faxes, receiving, 63
  - Hold, 62
  - Listening to messages, 71
  - Making a call, 61
  - Receiver volume, 32
  - Receiving a call, 62
  - Reception mode, changing, 71
  - Redialing, 67
  - Ringer volume, 32
  - Talking range, 19

## D

- Date, setting, 27-28
- Daylight Saving Time, 28
- Dial mode, 15
- Dialing
  - Automatic, 65, 81

- Direct Keypad, 82
  - Normal, 61, 77

- Direct Keypad Dialing, 82
- Display messages, 37, 96, 118-122
- Distinctive ring, 101
- Document feeder, 74
- Document guides, 74
- Document restrictions, 74
- Document sizes, 73
- Document, maximum scanning size, 73

## E

- ECM (Error Correction Mode), 84
- Extension telephone, using, 89

## F

- FAX reception mode, 29, 87
- Fax reception on TAD failure, 48
- Fax Signal Receive, 90

## H

- Halftone setting, 75
- Handset, 14
- Handset receiver volume (fax machine),  
30
- Headset jack, 20
- Housing, cleaning, 109

## I

- Imaging film, replacing, 21
- Intercom, 68

## J

- Jams, clearing, 123-124

## L

- Letters, entering, 26, 64, 79
- Line error, 112
- Loading paper, 23

## Index

Loading the document, 74

## M

Memory transmission, 86

Memory, substitute reception to, 92

Message List, 104

Messages

Erasing, 47, 72

Listening to, 46

Listening to on cordless handset, 71

Listening to remotely, 56

Setting allowed time, 48

## N

Normal dialing, 61, 77

Number of rings in FAX reception mode,  
87

Number of rings in TAD mode, 45

## O

OGM only mode, 49

OpenLCR, 33-42

Ordering parts, 125

Outgoing message, 43

Override Ringing, 53

## P

Paper jams, clearing, 123-124

Paper size setting, 24

Paper tray extension, 16

Paper, loading, 23

Power cord, 14

Print contrast setting, 24

Print head, cleaning, 107-108

Priority Call, 99

## R

Reception mode

FAX mode, 29, 87

TAD mode, 29, 44

TEL mode, 29, 88

Reception Ratio setting, 91

Redialing, 67, 83

Remote code number, 55

Remote operations, 55

Resolution, 75

Ringer volume

Cordless handset, 32

Fax machine, 31

## S

Scanning glass, cleaning, 108

Sender's name and number, entering,  
25-26

Setup List, 104

Speaker volume, 30

## T

TAD reception mode, 29, 44

TEL reception mode, 29, 88

TEL. LINE jack, 15

Telephone line cord, 15

Telephone Number List, 104

Time, setting, 27-28

Toll Saver function, 45, 55

Transaction Report, 105

Setting print condition, 106

Transfer Function, 50

Transferring calls, 69



## REMOTE OPERATION CARD

The card below is provided as a quick guide to remote operation. Cut it out and carry it with you when you go out.

### Remote Operation Guide

**SHARP**<sup>®</sup>

1. Call your fax from a touch-tone telephone, and press  when the outgoing message begins.
2. Enter your remote code:  .
3. Press  .
4. After listening to your messages, you can either hang up to save them, or enter one of the commands on the reverse side.

## REMOTE COMMANDS

- **PLAYBACK**

Play messages ..... **7** **#**  
 Move backward/repeat..... **2** **#**  
 Skip forward..... **5** **#**  
 Stop ..... **0** **#**  
 Play new messages only .. **6** **#**  
 (first stop playback)

- **ERASING MESSAGES**

Erase single message ..... **3** **#**  
 Erase all messages ..... **3** **3** **#**

- **RECORDING A MEMO**

Start ..... **\*6** **#**  
 End ..... **0** **#**

- **RECORDING A NEW OGM**

Start ..... **4** **\***

- **FAX RECEPTION MODES**

TAD mode..... **8** **1** **#**  
 FAX mode..... **8** **2** **#**  
 TEL mode..... **8** **3** **#**

- **TRANSFER FUNCTION**

Turn on ..... **9** **1** **#**  
 Turn off ..... **9** **2** **#**  
 New transfer number ..... **9** **0** **#**

→ (Tel. #)  
 → **#**

Record transfer OGM ..... **9** **3** **#**  
 To quickly disconnect..... **\*x** **\***

- **OGM ONLY MODE**

Turn on ..... **1** **1** **#**  
 Turn off ..... **1** **2** **#**



## **END USER LIMITED WARRANTY**

SHARP ELECTRONICS CORPORATION warrants to the first end user purchaser that this Sharp brand product (the "Product"), when shipped in its original container, will be free from defective workmanship and materials, and agrees that it will, at its option, either repair the defect or replace the defective Product or part thereof with a new or remanufactured equivalent at no charge to the purchaser for parts or labor for the period(s) set forth below.

This warranty does not apply to any appearance items of the Product nor to the additional excluded item(s) set forth below nor to any product the exterior of which has been damaged or defaced, which has been subjected to misuse, abnormal service or handling, or which has been altered or modified in design or construction.

In order to enforce the rights under this limited warranty, the purchaser should follow the steps set forth below and provided proof of purchase to the servicer.

To the extent permitted by applicable state law, the warranties set forth herein are in lieu of, and exclusive of, all other warranties, express or implied. Specifically, ALL OTHER WARRANTIES OTHER THAN THOSE SET FORTH ABOVE ARE EXCLUDED. ALL EXPRESS AND IMPLIED WARRANTIES INCLUDING THE WARRANTIES OF MERCHANTABILITY, FITNESS FOR USE, AND FITNESS FOR A PARTICULAR PURPOSE ARE SPECIFICALLY EXCLUDED. If, under applicable state law, implied warranties may not validly be disclaimed or excluded, the duration of such implied warranties is limited to the period(s) from the date of purchase set forth below.

Neither the sales personnel of the seller nor any other person is authorized to make any warranties other than those described above, or to extend the duration of any warranties beyond the time period described above on behalf of Sharp.

The warranties described herein shall be the sole and exclusive warranties granted by Sharp and shall be the sole and exclusive remedy available to the purchaser. Correction of defects, in the manner and for the period of time described herein, shall constitute complete fulfillment of all liabilities and responsibilities of Sharp to the purchaser with respect to the Product, and shall constitute full satisfaction of all claims, whether based on contract, negligence, strict liability or otherwise. In no event shall Sharp be liable, or in any way responsible, for any damages or defects in the Product which were caused by repairs or attempted repairs performed by anyone other than an authorized servicer. Nor shall Sharp be liable or in any way responsible for any incidental or consequential economic or property damage. Some states do not allow limits on warranties or on remedies for breach in certain transactions; in such state the limits herein may not apply.

Your Product:

Personal Facsimile UX-CL220

Warranty Period for this Product:

Ninety (90) days parts and labor from date of purchase.

Additional items excluded from warranty coverage:

Any consumable items such as paper or Imaging Film supplied with the Product.

What to do to obtain service:

Call Sharp at 1-877-794-8675 to obtain a Return Authorization Number and shipping instructions. A technician will troubleshoot your problem with you on the phone and if it is determined that your Product needs service, you will have your choice of having your unit repaired or replaced to any U.S. location. Be sure to have Proof of Purchase available.

For product information or customer assistance, please visit <http://www.sharpusa.com> on the World Wide Web or call **1-877-794-8675**.

**SHARP ELECTRONICS CORPORATION**

Sharp Plaza,

Mahwah, New Jersey 07430-2135

# ***IMPORTANT SERVICE INFORMATION***

## **If a Problem Occurs**

Most operational questions can be answered by referring to this "Setup Guide and Operation Manual". Also, for your convenience, you will find answers to most frequently asked questions on our website at [www.sharpusa.com/](http://www.sharpusa.com/), or by sending e-mail to [faxsupport@sharpsec.com](mailto:faxsupport@sharpsec.com). Should you require further assistance, call 1-877-794-8675; a Customer Relations Specialist will assist you. Before your call, please be ready to provide the model number of your product, serial number, date of purchase, description of the problem, and a valid credit card number (should it be required).

## **How Exchange is Obtained**

A replacement unit in exchange for your fax is provided by Sharp to any U.S. location. You will be required to provide consent for acceptance of an exchange unit and provide credit card authorization. At that time, Sharp will ship to you, at no cost, an exchange for your defective product. The exchange unit we ship to you will be new or remanufactured. Upon your receipt of the exchange unit, packaging and shipping instructions will be enclosed for you to return the defective unit. Upon Sharp's receipt of the defective unit, your credit card hold will be released.

## **How Warranty Repair Service is Obtained**

If you prefer that we repair your unit instead of replacing it, our Customer Relations Specialists at 1-877-794-8675 will explain how to obtain warranty repair service. **Please be sure to retain the original packaging materials in order to facilitate shipment.** Upon repair of your unit, Sharp will promptly return it at no cost to you at any U.S. location.

## **What You Must Do**

Your Product is designed to perform with a minimum amount of user maintenance. However, you are responsible for the required user maintenance described in the "Operation Manual". This requires user maintenance including replacement of the imaging film and battery, cleaning of the unit and removal of dust and foreign matter, clearing of paper misfeeds, and proper routine and preventive maintenance.

## **Service After Expiration of Warranty Coverage**

Should you require service repair after warranty coverage has expired, contact Sharp at 1-877-794-8675 for information.

## **To Purchase Consumables From Sharp**

Visit [www.sharplace.com/](http://www.sharplace.com/) or call Sharp at 1-877-794-8675 to order replacement Sharp Thermal Ribbons & Accessories. Before your call, please be ready to provide the model number of your product, and a valid credit card number. Consumables may also be obtained through your reseller.



# SHARP®

**SHARP ELECTRONICS CORPORATION**

**Sharp Plaza, Mahwah, New Jersey 07430-2135**

## SHARP CORPORATION

### FOR YOUR RECORDS

Please record the model number and serial number below, for easy reference, in case of loss or theft. These numbers are located on the rear side of the unit. Space is also provided for other relevant information.

Model Number UX-CL220

Serial Number \_\_\_\_\_

Date of Purchase \_\_\_\_\_

Place of Purchase \_\_\_\_\_

PRINTED IN THAILAND

(TINSE4267XHTZ) ①